



GLXD6+

Guitar Pedal Receiver

Online user guide for GLXD6+ wireless system. Includes setup instructions, specifications, and more.
Version: 1.1 (2023-B)

Table of Contents

GLXD6+ Guitar Pedal Receiver	3	Tuner Menu	13
System Overview	3	Tuner Options	13
Features	3	Indicator: Needle or Strobe	13
Guitar Pedal Receiver	3	Choosing Live or Mute Audio Output	14
Display Screen, Indicators, and Controls	4	Display Brightness	15
Receiver Mode	4	Detune	15
Tuner Mode	5	Sharps and Flats	15
Set Up the Receiver	6	Reference Pitch	16
Bodypack Transmitter	6	Using the Tuner	16
Transmitter Status LED	8	Needle Mode	16
Wearing the Bodypack	8	Strobe Mode	17
Install Transmitter Batteries	8	Using a Third-Party Power Supply	17
Batteries and Charging	9	Firmware	18
Charging from an AC Power Source	9	Resetting Components	18
Charging Status LEDs	9	Resetting the Receiver	18
Charging Times and Transmitter Runtimes	10	Resetting the Transmitter	19
Transmitter Battery Meter	10	Troubleshooting	19
Important Tips for Care and Storage of Shure Rechargeable Batteries	11	Accessories	20
Tips to Improve Wireless System Performance	11	Specifications	21
Additional Tips	11	Diagrams	25
Receiver Operation	11	Frequency Tables	26
Audio Gain Adjustment	11	IMPORTANT SAFETY INSTRUCTIONS	32
Locking and Unlocking the Controls	12	WARNING	34
Identifying Linked Transmitters and Receivers with Remote ID	12	Note:	34
Receiver Band Modes	12	Information to the user	34
		Certifications	35

GLXD6+ Guitar Pedal Receiver

System Overview

GLX-D+ Dual Band Digital Wireless offers confidence without complexity. Dual-band operation in 2.4 and 5.8 GHz more than doubles the available bandwidth to avoid interference without audio interruption. The receiver is compatible with a selection of lavalier, headset, and vocal microphones. The included lithium-ion battery offers up to 12 hours of runtime, and can be charged directly on the receiver or via USB-C.

Features

- Exceptional digital audio clarity
- Compatible with multiple legendary microphone options
- Automatically moves away from interference without audio interruption
- Operates in 2.4 and 5.8 GHz spectrum*
- Rechargeable battery delivers up to 12 hours of runtime
- Rock-solid RF performance for multiple system installations
- License-free frequency range

Note: region dependent

Guitar Pedal Receiver

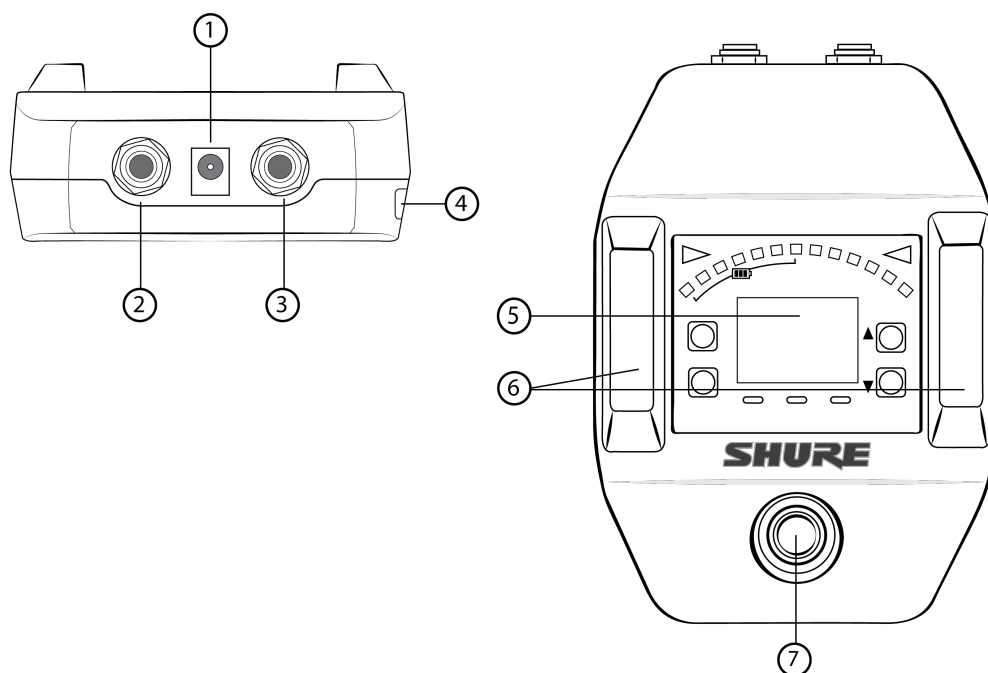

① DC power connector	Connect DC power supply (9 to 15 V DC, 400 mA minimum). Note: Compatible with positive tip or negative tip power supplies.
② INSTR IN	Use receiver as a wired guitar pedal tuner.
③ INSTR OUT	Connect to amplifier or mixer. Note: If using multiple effects pedals, place the receiver pedal first in the signal chain.
④ USB-C port	Connect to computer to download firmware updates.
⑤ Display	Shows receiver and tuner settings. See below for more information on display controls.
⑥ Antenna	Two antennas per receiver. Antennas pick up the signal from the transmitter.
⑦ Footswitch	Press to select receiver or tuner mode.

Display Screen, Indicators, and Controls

The controls and display offer specific functionality depending on which mode is selected:

Receiver Mode

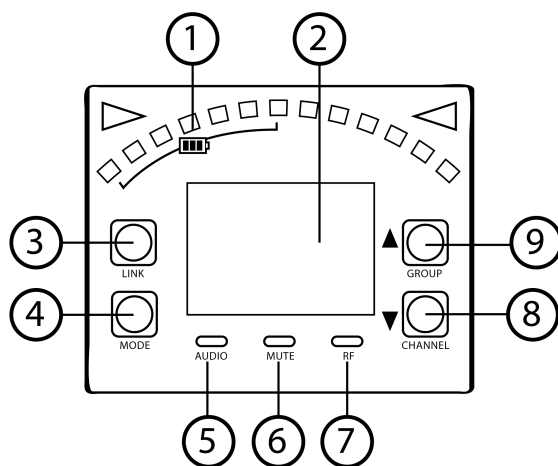

① Transmitter battery meter	Illuminated segments indicate remaining battery life.
② Display	Group Channel LK (controls locked)

	UN (controls unlocked) -- (frequency not available)
③ Link button	Press to manually link receiver to a transmitter or to activate the remote ID function.
④ Mode button	Press to enable audio gain adjustment. Use ▲ ▼ buttons to adjust gain.
⑤ Audio LED	Illumination corresponds to audio level. Rapid flashing indicates audio clipping.
⑥ Mute LED	Illuminates when audio output is muted.
⑦ RF LED	<ul style="list-style-type: none"> • ON = Linked transmitter is on • Flashing = Searching for transmitter • OFF = Linked transmitter off or transmitter unlinked
⑧ Channel button	Press to select and edit channel.
⑨ Group button	Press to select and edit group.

Tuner Mode

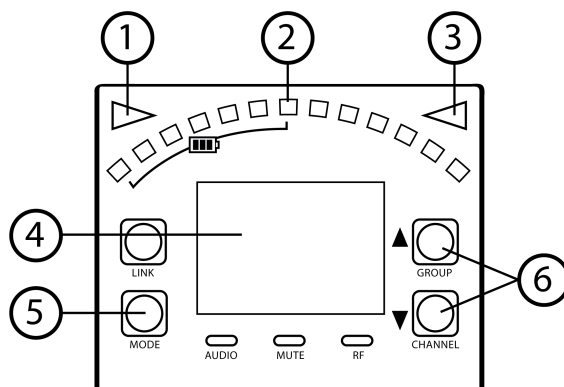

① Flat indicator	Illuminates when note is flat.
② Tuning bar display	LEDs illuminate to indicate tuning deviation.
③ Sharp indicator	Illuminates when note is sharp.
④ Note display	Displays the name of the note or (--) if the tuner is idle.
⑤ Mode button	Press to enter tuner menu settings.
⑥ Arrow buttons	Use ▲ ▼ buttons to select and edit menu settings.

⑦ **Frequency detuned/Reference pitch offset indicator**

A dot is displayed when the tuning or pitch has been set to a non-standard value.

Note: Non-standard tuning or pitch settings scroll across the receiver display during power-up.

Set Up the Receiver

1. Connect the PS24 power supply to the receiver and plug the cord into an AC power source.
2. Connect the transmitter to the instrument.
3. Connect the audio output to an amplifier or mixer.

Note: The receiver powers on after the power supply and ¼" cable are connected.

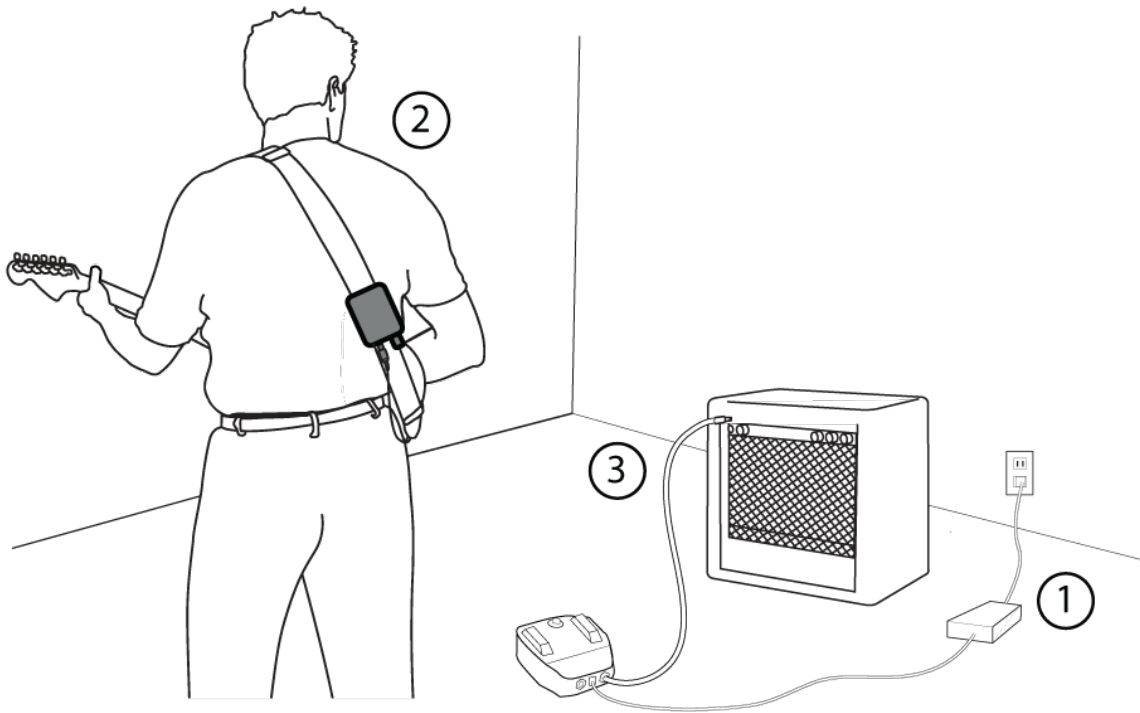

Bodypack Transmitter

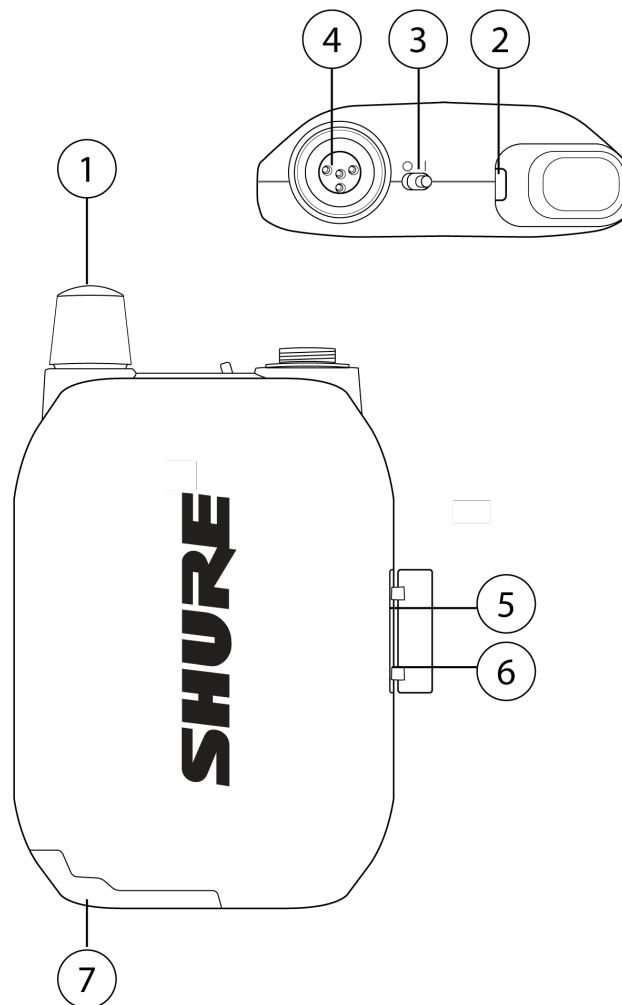

① Antenna

Carries wireless signal.

② Status LED

LED color and state indicate transmitter status.

③ Power switch

Turns the transmitter on/off.

④ TA4M input port

Connects to a 4-Pin mini connector (TA4F) microphone or instrument cable.

⑤ USB-C charging port

Connect to USB battery charger.

⑥ Link button

- Press and hold within 5 seconds of power-on to manually link with receiver.
- Press momentarily to activate remote ID function.

⑦ Battery compartment

Holds 1 Shure rechargeable battery.

Transmitter Status LED

LED is green during normal operation.

LED color or flashing indicates a change in transmitter status as shown in the following table:

Color	State	Description
Green	Flashing (slow)	Transmitter attempting relink with receiver
	Flashing (fast)	Unlinked transmitter searching for receiver
	Flashes 3 times	Indicates locked transmitter when power switch is pressed
Red	On	Battery life < 1 hour
	Flashing	Battery life < 30 minutes
Red/Green	Flashing	Remote ID active
Amber	Flashing	Battery error; remove and insert again, or replace battery

Wearing the Bodypack

Clip the bodypack to a belt or slide a guitar strap through the bodypack clip as shown.

For best results, the belt should be pressed against the base of the clip.

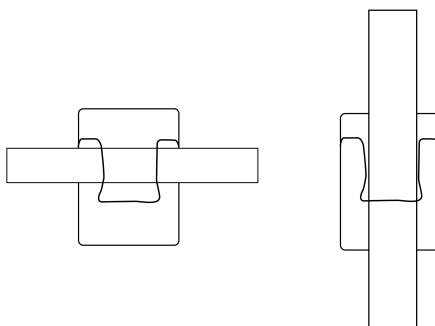

Install Transmitter Batteries

Important: Always fully charge a new battery before first use.

1. Move the locking lever to the open position and slide the battery door open.
2. Place the battery into the transmitter.
3. Close the battery door.

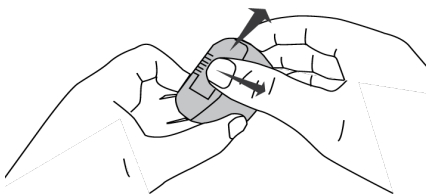

Batteries and Charging

GLX-D+ transmitters are powered by Shure SB904 lithium-ion rechargeable batteries. Advanced battery chemistry maximizes runtimes with zero memory effects, eliminating the need to discharge batteries prior to charging.

When not in use, recommended battery storage temperature is 10°C (50°F) to 25°C (77°F).

Note: The transmitter will not pass RF or audio signals when connected to the charging cable.

The following battery charging options are available:

Charging from an AC Power Source

1. Plug the charging cable into the charging port on the transmitter.
2. Plug the charging cable into an AC power source.

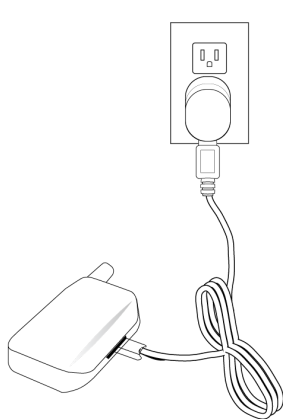

Charging Status LEDs

LED Color	Description
Green (solid)	Device is fully charged
Red (solid)	Charging
Amber (flashing)	Out of temperature range, or battery error
Off	Power supply is disconnected, or no device is docked in the charging bay

Charging Times and Transmitter Runtimes

Use the following table to determine approximate battery runtime based on the duration of charging time when in 5.8 GHz mode. Times shown are in hours and minutes. Transmitters automatically power-off after approximately 1 hour to conserve battery life if the signal from a linked receiver is not detected.

Receiver Bay or AC Power Source Charging	Transmitter Runtime
0:15	up to 1:30
0:30	up to 3:00
1:00	up to 6:00
3:00	up to 11:30*

*Storage time or excessive heat will reduce maximum runtime.

Note: If receiver is powered off and remains plugged in, battery will continue charging.

Transmitter Battery Meter

The number of segments illuminated on the meter indicates the remaining battery life for a linked transmitter:

- ① = > 30 min
- ② = > 2 hours
- ③ = > 4 hours
- ④ = > 6 hours
- ⑤ = > 8 hours
- ⑥ = > 10 hours
- ⑦ = > 11.5 hours

Note: The LEDs will cycle on/off while battery life is being calculated.

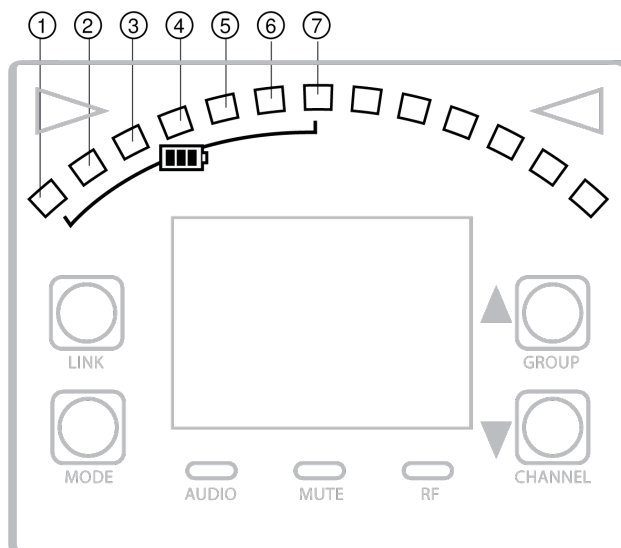

Important Tips for Care and Storage of Shure Rechargeable Batteries

Proper care and storage of Shure batteries results in reliable performance and ensures a long lifetime.

- Always store batteries and transmitters at room temperature
- Ideally, batteries should be charged to approximately 40% of capacity for long-term storage
- During storage, check batteries every 6 months and recharge to 40% of capacity as needed

Tips to Improve Wireless System Performance

If you encounter interference or dropouts, try the following suggestions:

1. Place receiver at least 3 meters (10 feet) away from Wi-Fi access points, computers, or other active 2.4 GHz and 5.8 GHz sources.
 - Avoid heavy Wi-Fi traffic activities such as downloading large files or viewing a movie.
 - Turn on any Wi-Fi prior to turning on receivers and scanning for the best channel.
2. Reduce transmitter-to-receiver distance by placing receivers on stage or above the audience with a clear line of sight to the transmitter.
 - Move receiver to the top of the equipment rack for a clear line of sight.
 - Mount antennas remotely to place closer to transmitters and improve RF reliability if receivers cannot be moved closer.
 - Make sure people do not block the line of sight between receiver and transmitter.

Additional Tips

- Do not place competitive 2.4 GHz and 5.8 GHz receivers near GLXD4R+ receivers.
- Scan for the best available channel by pressing the channel button.
- Keep transmitters more than 2 meters (6 feet) apart. This is less critical with shorter receiver-to-transmitter distances.

Note: If transmitters are within 6 inches of non-GLX-D+ transmitters or microphone cartridges, audible noise is possible.

- Move transmitter and receiver away from metal or other dense materials.
- During sound check, mark trouble spots and ask performers to avoid those areas.

Receiver Operation

Audio Gain Adjustment

Transmitter gain has an adjustment range from -20 dB to +40 dB in 1 dB increments.

Tip: Try the 0 dB (unity gain) setting as a starting point, and then make gain adjustments if necessary.

1. Press and hold the mode button on the receiver until dB appears on the display.
2. Press the up/down arrows to adjust the gain. For faster adjustments, press and hold the buttons.

Note: The intensity of the green audio LED corresponds to the audio level. Rapid flashing indicates audio clipping. Reduce the gain to remove the overload.

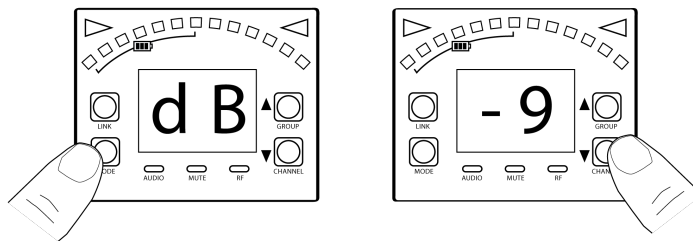

Locking and Unlocking the Controls

The controls of the receiver and transmitter can be locked to prevent unauthorized setting changes or power-off. The lock status is not changed by power cycles.

Locking the Receiver Controls

Simultaneously press and hold the group and channel buttons until LK appears on the screen. Repeat to unlock.

- LK is displayed if a locked control is pressed
- UN is displayed momentarily to confirm the unlock command

Locking the Transmitter Controls

To lock directly from the transmitter:

Start with the transmitter off, then press and hold the link button while turning on the transmitter. Release the link button when the transmitter powers on to prevent an accidental factory reset. The lock icon appears on the receiver screen when locked. Repeat sequence to unlock.

To lock from the receiver front panel:

Simultaneously press and hold the group and link buttons for approximately 2 seconds until the flashing lock icon appears on the receiver screen. Repeat sequence to unlock.

Note: The transmitter status LED will flash if a locked switch is set to the off position.

Identifying Linked Transmitters and Receivers with Remote ID

Use the remote ID feature to identify linked transmitter and receiver pairs in multiple receiver systems.

To activate remote ID:

1. Momentarily press the link button on the transmitter or receiver.
2. The screen of the linked receiver will blink and display ID, while the status LED on the linked transmitter will flash red/green.
3. To exit remote ID mode, momentarily press the link button or allow the function to timeout.

Receiver Band Modes

There are 3 band modes available for GLXD+ receivers.* The band mode options are:

- 2.4 GHz-only mode
- 5.8 GHz-only mode
- Best band mode – 2.4 and 5.8 GHz (default)

Note: region dependent

To change the band mode:

1. Press and hold the channel button while powering on the receiver. Continue to hold the channel button for approximately 5 seconds until the band selection menu opens.
2. Press the up/down gain button to select a band mode. The screen will flash momentarily and scan for the best channel to use.

Note: Linked receivers and transmitters must be able to operate in the same band. Transmitters that don't support the selected band mode will unlink from the receiver.

Tuner Menu

Enter tuner mode by pressing the footswitch.

In tuner mode, the controls will only affect tuner functions. RF and audio settings are not affected.

Note:

- **Wired use:** Wired input does not load the guitar signal, eliminating the need for bypass switches. The unit passes wired signal if power is lost to the pedal.
- **Wireless use:** Bypass does not apply because the pedal needs to be powered on to receive wireless signal.

Tuner Options

- Indicator: Needle or Strobe
- Output: Live, Mute, or Both
- Display Brightness
- Detune
- Sharps and Flats
- Reference Pitch

Selecting and Editing Tuner Menu Settings

Use the following buttons to select and edit the tuner menu settings:

- Use the mode button to access the menu and scroll between menu settings.
- Use the ▲ ▼ buttons to change a menu parameter.
- Use the footswitch to enter and save parameter changes.

Indicator: Needle or Strobe

The tuner indicator can be set to display a needle style or strobe style.

Needle

A single LED will illuminate on the tuning bar to indicate sharp or flat. The green center LED will illuminate when the note is in tune.

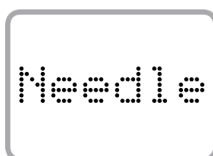

Strobe

A sequence of three LEDs will travel across the tuning bar in the direction of sharp or flat. The LEDs will remain stationary when the note is in tune.

Note: Indicator and Output settings are displayed in a scroll from left to right.



Choosing Live or Mute Audio Output

Set the audio output to the following modes when the footswitch is pressed in tuner mode.

Note: Text for the output settings are displayed in a scroll from left to right.

Mode	Footswitch Function
Live	Receiver Display (audio Live) ↔ Tuner Display (audio Live)
Mute	Receiver Display (audio Live) ↔ Tuner Display (audio Mute)
Both	Tuner Display (audio Mute) ↔ Tuner Display (audio Live)*

***Note:** In Both mode, the pedal powers up in Receiver Display. Press the footswitch to enter tuner mode.



Display Brightness

The receiver has a built-in light sensor to automatically adjust the display brightness.

To manually adjust the brightness choose one of the following settings:



*A = automatic



*1 = low



*2 = medium



*3 = high

Detune

The tuner can be set to display standard tuning for instruments that have been detuned up sharp or flat in the following increments:

- Up to 5 steps sharp (#1-#2 -#3-#4-#5)
- Up to 6 steps flat (b6-b5-b4-b3-b2-b1)

The notation for standard tuning is b0

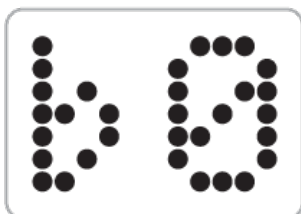

b0
= Standard Tuning



Example of note displayed in Detune mode

Note: A dot appears on the display as a reminder that the pedal is detuned.

Sharps and Flats

Adds sharp or flat symbols to the display of non-natural notes.



Sharps and Flats



Flats only



Sharps only

Reference Pitch

The reference pitch can be offset from standard A440 in a range of 432 Hz to 447 Hz in 1 Hz increments.

When adjusting the pitch, the last 2 digits of the value will be displayed. For example, "32" would appear on the display when the pitch has been set to 432 Hz.

A dot appears on the display as a reminder that the reference pitch has been offset.

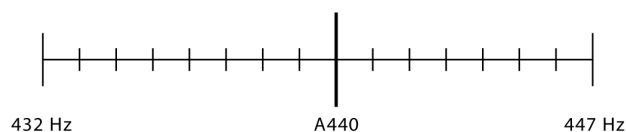

Using the Tuner

1. Press the footswitch to enter tuner mode.
2. Play each note individually. The display shows the name of the note.
3. Adjust tuning until both indicators illuminate and the needle or strobe indicate that tuning is correct.

Needle Mode

Both tuning indicators and the center green segment will illuminate when the note is in tune.

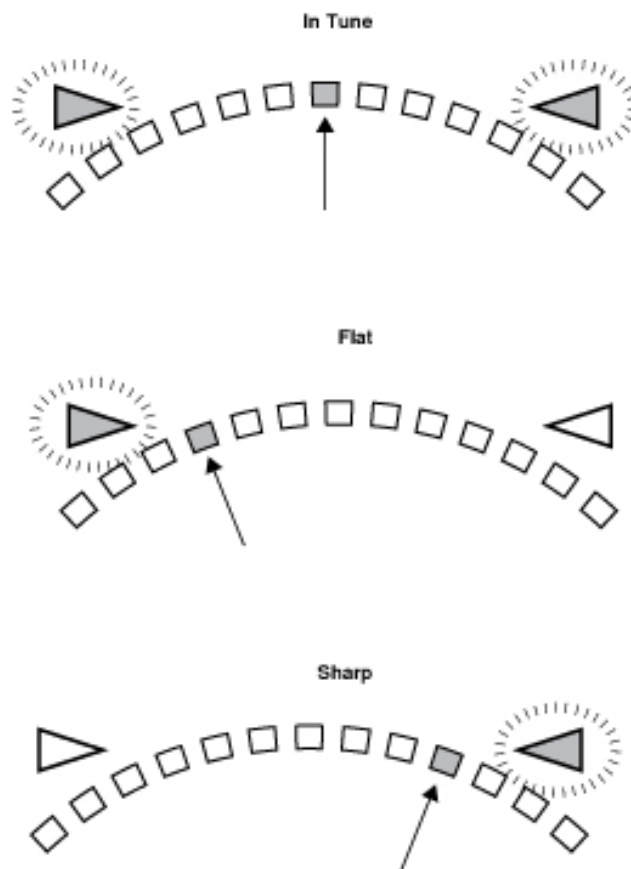

Strobe Mode

Both tuning indicators will illuminate and the strobe segments will remain stationary when the note is in tune.

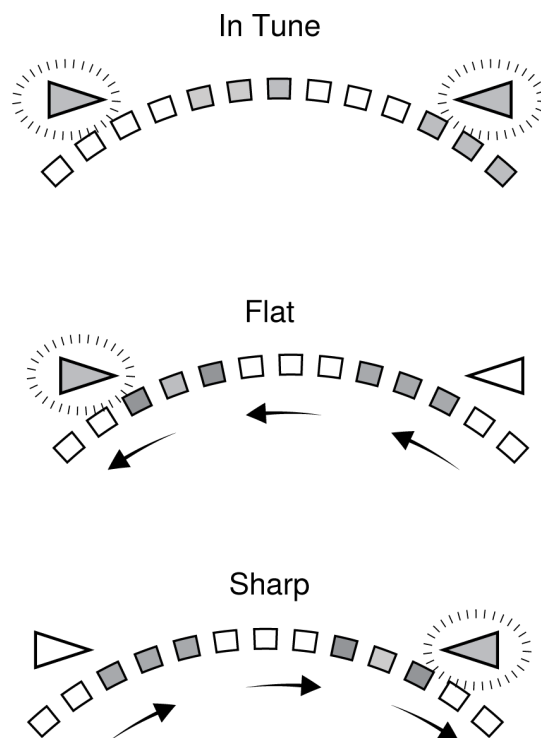

Using a Third-Party Power Supply

To power your wireless receiver pedal, we recommend using the included power supply or a power supply with isolated power outputs.

If using a power supply with isolated power outputs, use a power outlet rated at a minimum of 400 mA.

However, if using other third-party power supplies:

- Check the power consumption for each pedal in a daisy-chain setup. You must know the total power consumption for all of your pedals to avoid overloading the power supply.
- If no power requirement is listed on the pedal, consult the pedal manufacturer.

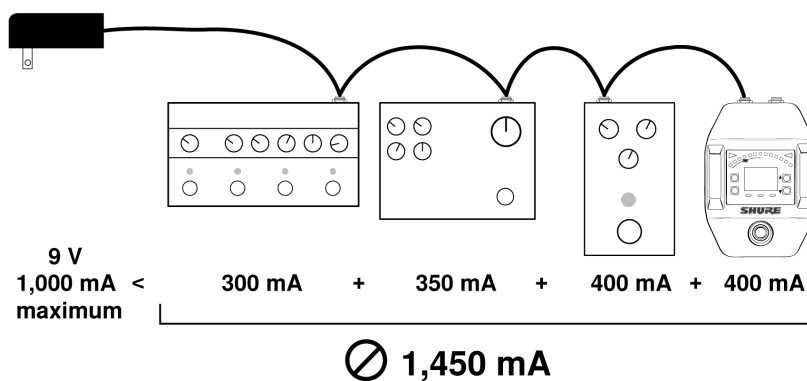
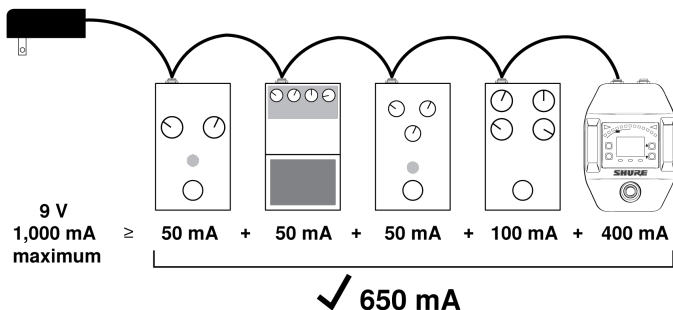

Firmware

New versions of the firmware can be uploaded and installed using the Shure Update Utility tool.

Download Shure Update Utility from [shure.com](https://www.shure.com)

To update your firmware, connect the device to your computer using a USB-C cable and open the Shure Update Utility.

Resetting Components

Use the reset function if it is necessary to restore the transmitter or receiver to their factory settings.

Resetting the Receiver

Restores the receiver to the following factory settings:

- Gain level = default
- Controls = unlocked

Press and hold the link button while turning on the receiver power until the display shows RE.

Note: When reset is complete, the receiver will automatically initiate linking to search for a transmitter. Press and hold the transmitter link button within five seconds of powering-on to complete the link.

Resetting the Transmitter

Restores the transmitter to the following factory settings:

- Controls = unlocked

Press and hold the transmitter link button while turning on the transmitter until power LED turns off.

When the link button is released, the transmitter will automatically initiate linking to find an available receiver. Press the link button on an available receiver to relink.

Troubleshooting

Issue	Indicator Status	Solution
No sound or faint sound	Receiver RF LED on	Verify all sound system connections or adjust gain as needed. Verify that the receiver is connected to mixer/amplifier.
	Receiver RF LED off	Turn on transmitter. Make sure the batteries are installed correctly. Link transmitter and receiver. Charge or change transmitter battery.
	Receiver display off	Make sure AC adapter is securely plugged into electrical outlet. Make sure receiver is powered on.
	Transmitter indicator LED flashing red	Charge or change transmitter battery.
	Transmitter plugged into charger.	Disconnect transmitter from charger.
Audio artifacts or dropouts	RF LED flickering or off	Change receiver and transmitter to a different group and/or channel. Identify nearby sources of interference (cell phones, Wi-Fi access points, signal processor, etc.) and shutdown or remove source. Charge or change transmitter battery. Ensure that receiver and transmitter are positioned within system parameters. System must be set up within recommended range and receiver kept away from metallic surfaces.

Issue	Indicator Status	Solution
		Transmitter must be used in line of sight from receiver for optimal sound.
Distortion	OL indicator appears on receiver display	Reduce transmitter gain.
Transmitter and receiver link unsuccessful	Transmitter and receiver LEDs flash to indicate that linking started, but the link fails	Update both components to the latest firmware version.
Sound level variations when switching to different sources	N/A	Adjust transmitter gain as necessary.
Receiver/transmitter won't turn off	Transmitter LED flashing rapidly	Controls locked.
Receiver gain control cannot be adjusted	N/A	Check transmitter. Transmitter must be on to enable gain changes.
Receiver controls cannot be adjusted	LK shown on receiver display when buttons are pressed	Controls locked.
Transmitter ID function does not respond	Transmitter LED flashes green 3 times	Controls locked.
Transmitter information does not appear on the receiver display	N/A	Linked transmitter is off or the receiver is not linked to a transmitter.
Transmitter powers off after 1 hour	Transmitter status LED off	Transmitters automatically power-off after 1 hour to conserve battery life if the signal from a linked receiver is not detected. Make sure that linked receiver is turned on.

Accessories

Cable, Instrument, 2.5 foot (.75 m), 4 Pin Mini Connector (TA4F) to 1/4-inch Connector.	WA302
Cable, Instrument, 2-foot (0.7m), 4-pin Mini Connector (TA4F) with Right-Angle 1/4-inch Connector, used with Shure Wireless Bodypack Transmitters	WA304
Shure Rechargeable Battery	SB904
USB-C Battery Charger	SBC10-USBC
Premium Guitar Cable TQG Threaded Connector	WA305
Power Supply	PS24

Specifications

Tuning Bandwidth

Z2	2400 - 2483.5 MHz
Z3	2400 - 2483.5 MHz and 5725 - 5850 MHz
Z4	2400 - 2483.5 MHz and 5725 - 5875 MHz
Z5	2400 - 2483.5 MHz and 5725 - 5825 MHz

Dependent on frequency band

Transmit Mode

Shure proprietary digital

RF Output Power

10 mW E.I.R.P. maximum

Operating Temperature Range

0°C (32°F) to 50°C (122°F)

Polarity

Positive voltage applied to the tip of the guitar cable phone plug produces positive voltage at the tip of the high impedance ¼-inch output

Audio Frequency Response

20 Hz – 20 kHz

Dynamic Range

120 dB, A-weighted

RF Sensitivity

-88 dBm, typical

Total Harmonic Distortion

0.02%, typical

Battery Life

Up to 11.5 hours

Guitar Tuner

Tuning Accuracy	±1 cent
Tuning Range	F#0 to C8

Channel Count

Up to 4 typical, 8 optimal

2.4 GHz only: Up to 4 typical, 5 optimal

GLXD6+

Power Requirements

9 V – 15 V, 400 mA (efficiency level VI power supply)

Antenna Type

Dual-band PIFA

Dimensions

5.4 x 3.7 x 1.89 in. (138 x 95 x 48 mm)

Weight

19.75 oz (560 g)

Housing

Aluminum alloy

Spurious Rejection

> 35 dB, typical

Gain Adjustment Range

-20 to 40 dB in 1 dB steps

Audio Input Modes

Tuner or True Bypass

AUDIO OUTPUT:

Configuration

6.35 mm (1/4") output

Impedance balanced

Impedance

6.35 mm (1/4") output

100 Ω (50 Ω , Unbalanced)

Maximum Audio Output Level

6.35 mm (1/4") connector (into 3 k Ω load)

+8.5 dBV

Pin Assignments

6.35 mm (1/4") connector

Tip=audio, Ring=no audio, Sleeve=ground

RECEIVER ANTENNA INPUT:

Impedance

50 Ω

Maximum Input Level

-20 dBm

GLXD1+

Power Requirements

Shure Rechargeable Li-Ion Battery	SB904
USB Power Supply (US/Canada)	SBC10-USB15WSUSTWJ

Antenna Type

Dual-band Internal Monopole

Dimensions

4.5 x 2.6 x 1.1 in. (115 x 66.94 x 28.51 mm), (H x W x D)

Weight

5.4 oz (153.1 g), without battery

Housing

Aluminum alloy, ABS plastic

Input Impedance900 k Ω **TX INPUT:****Connector**

4-pin male mini connector (TA4M)

Maximum Input Level+8.4 dBV (7.5 V_{p-p})**Configuration**

Unbalanced

Pin Assignments

1	Ground (cable shield)
2	+ 5 V bias
3	Audio
4	Tied through active load to ground (on instrument adapter cable, pin 4 floats)

SB904

Battery Type

Rechargeable Li-Ion

Nominal Capacity

2420 mAh (8.71 Wh)

Nominal Voltage

3.6 V

Dimensions

2.87 x 0.83 x 0.82 inches (72.8 x 20.96 x 20.80 mm), (H x W x D)

Weight

1.89 oz. (53.7 g)

Housing

PC/ABS

Ambient Temperature Range

Charging:	0°C (32°F) to 40°C (104°F)
Operating:	-18 °C (0 °F) to 45 °C (113 °F)

SBC10-904**DC Input Voltage**

5 V

Ambient Temperature Range*Operating:*

0°C (32°F) to 40°C (104°F)

SBC10-USB15W Power Supply**Input Voltage Range**

100 to 240 V AC

Maximum Input Power

600 mA @ 100 V AC (full load)

Output Voltage

5 v DC @ 3 A

Maximum Output Power

15 W

SBC10-USB Power Supply**Input Voltage Range**

100 to 240 V AC

Maximum Input Power

200 mA @ 100 V AC (full load)

Output Voltage

5 v DC @ 1 A

Maximum Output Power

5 W

Diagrams

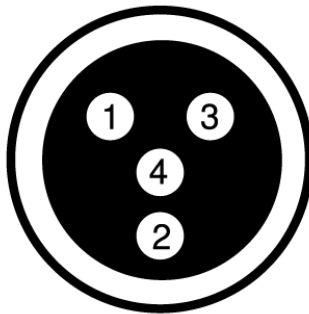

TA4M Connector

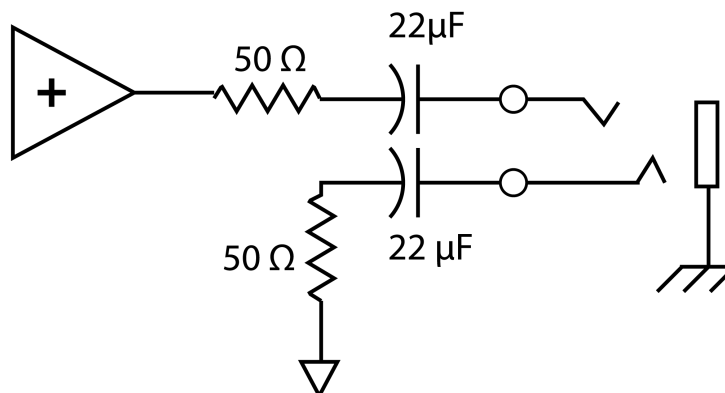
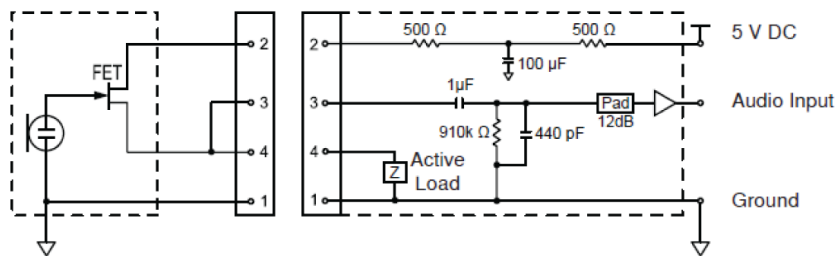

Frequency Tables

Z2 (2.4 GHz only)

Group 1						
Gr 1 - Ch 1	2424	2425	2442	2443	2462	2464
Gr 1 - Ch 2	2418	2419	2448	2450	2469	2471
Gr 1 - Ch 3	2411	2413	2430	2431	2476	2477
Gr 1 - Ch 4	2405	2406	2436	2437	2455	2457
Group 2						
Gr 2 - Ch 1	2423	2424	2443	2444	2473	2474
Gr 2 - Ch 2	2404	2405	2426	2427	2456	2457
Gr 2 - Ch 3	2410	2411	2431	2432	2448	2449
Gr 2 - Ch 4	2417	2418	2451	2452	2468	2469
Gr 2 - Ch 5	2437	2438	2462	2463	2477	2478
Group 3						
Gr 3 - Ch 1	2415		2416		2443	
Gr 3 - Ch 2	2422		2423		2439	
Gr 3 - Ch 3	2426		2427		2457	
Gr 3 - Ch 4	2447		2448		2468	
Gr 3 - Ch 5	2409		2451		2452	
Gr 3 - Ch 6	2431		2462		2463	
Gr 3 - Ch 7	2404		2473		2474	
Gr 3 - Ch 8	2435		2477		2478	
Group 4						
2404	2406	2408	2410	2412	2414	
2416	2418	2420	2422	2424	2426	
2428	2430	2432	2434	2436	2438	
2440	2442	2444	2446	2448	2450	
2452	2454	2456	2458	2460	2462	
2464	2466	2468	2470	2472	2474	

Group 4					
2476	2478				
Group A					
2405	2412	2418	2425	2431	2438
2444	2450	2457	2464	2471	2477
Group B					
2404	2409	2414	2419	2425	2431
2436	2441	2446	2452	2458	2463
2468	2473	2478			

Z3

Group 1 (2.4 GHz)					
Gr 1 - Ch 1		2405	2323	2441	2465
Gr 1 - Ch 2		2411	2429	2447	2471
Gr 1 - Ch 3		2417	2435	2453	2477
Group 2 (2.4 GHz)					
Gr 2 - Ch 1		2404	2424	2444	2464
Gr 2 - Ch 2		2409	2429	2449	2469
Gr 2 - Ch 3		2414	2434	2454	2474
Gr 2 - Ch 4		2419	2439	2459	2478
Group 3 (2.4 GHz)					
2405	2408	2411	2414	2417	2420
2423	2426	2429	2432	2435	2438
2441	2444	2447	2450	2453	2456
2459	2462	2465	2468	2471	2474
2477					
Group A (2.4 GHz)					
2405	2411	2417	2423	2429	2435
2441	2447	2453	2459	2465	2471
2477					

Group B (2.4 GHz)					
2404	2409	2414	2419	2424	2429
2434	2439	2444	2449	2454	2459
2464	2469	2474	2478		
Group 1 (5.8 GHz)					
Gr 1 - Ch 1		5730	5760	5790	5820
Gr 1 - Ch 2		5736	5766	5796	5826
Gr 1 - Ch 3		5742	5772	5802	5832
Gr 1 - Ch 4		5748	5778	5808	5838
Gr 1 - Ch 5		5754	5784	5814	5845
Group 2 (5.8 GHz)					
Gr 2 - Ch 1		5729	5759	5789	5819
Gr 2 - Ch 2		5734	5764	5794	5824
Gr 2 - Ch 3		5739	5769	5799	5829
Gr 2 - Ch 4		5744	5774	5804	5836
Gr 2 - Ch 5		5749	5779	5809	5841
Gr 2 - Ch 6		5754	5784	5814	5846
Group 3 (5.8 GHz)					
5730	5733	5736	5739	5742	5745
5748	5751	5754	5757	5760	5763
5766	5769	5772	5775	5778	5781
5784	5787	5790	5793	5796	5799
5802	5805	5808	5811	5814	5817
5820	5823	5826	5829	5832	5835
5838	5841	5845			
Group A (5.8 GHz)					
5730	5736	5742	5748	5754	5760
5766	5772	5778	5784	5790	5796
5802	5808	5814	5820	5826	5832
5838	5845				

Group B (5.8 GHz)					
5729	5734	5739	5744	5749	5754
5759	5764	5769	5774	5779	5784
5789	5794	5799	5804	5809	5814
5819	5824	5829	5836	5841	5846

Z4

Group 1 (2.4 GHz)					
Gr 1 - Ch 1		2405	2323	2441	2465
Gr 1 - Ch 2		2411	2429	2447	2471
Gr 1 - Ch 3		2417	2435	2453	2477
Group 2 (2.4 GHz)					
Gr 2 - Ch 1		2404	2424	2444	2464
Gr 2 - Ch 2		2409	2429	2449	2469
Gr 2 - Ch 3		2414	2434	2454	2474
Gr 2 - Ch 4		2419	2439	2459	2478
Group 3 (2.4 GHz)					
2405	2408	2411	2414	2417	2420
2423	2426	2429	2432	2435	2438
2441	2444	2447	2450	2453	2456
2459	2462	2465	2468	2471	2474
2477					
Group A (2.4 GHz)					
2405	2411	2417	2423	2429	2435
2441	2447	2453	2459	2465	2471
2477					
Group B (2.4 GHz)					
2404	2409	2414	2419	2424	2429
2434	2439	2444	2449	2454	2459
2464	2469	2474	2478		

Group 1 (5.8 GHz)					
Gr 1 - Ch 1		5730	5766	5802	5838
Gr 1 - Ch 2		5736	5772	5808	5844
Gr 1 - Ch 3		5742	5778	5814	5851
Gr 1 - Ch 4		5748	5784	5820	5858
Gr 1 - Ch 5		5754	5790	5826	5864
Gr 1 - Ch 6		5760	5796	5832	5870
Group 2 (5.8 GHz)					
Gr 2 - Ch 1		5729	5764	5799	5834
Gr 2 - Ch 2		5734	5769	5804	5839
Gr 2 - Ch 3		5739	5774	5809	5850
Gr 2 - Ch 4		5744	5779	5814	5856
Gr 2 - Ch 5		5749	5784	5819	5861
Gr 2 - Ch 6		5754	5789	5824	5866
Gr 2 - Ch 7		5759	5794	5829	5871
Group 3 (5.8 GHz)					
5730	5733	5736	5739	5742	5745
5748	5751	5754	5757	5760	5763
5766	5769	5772	5775	5778	5781
5784	5787	5790	5793	5796	5799
5802	5805	5808	5811	5814	5817
5820	5823	5826	5829	5832	5835
5838	5841	5844	5847	5851	5855
5858	5861	5864	5867	5870	
Group A (5.8 GHz)					
5730	5736	5742	5748	5754	5760
5766	5772	5778	5784	5790	5796
5802	5808	5814	5820	5826	5832
5838	5844	5851	5858	5864	5870

Group B (5.8 GHz)					
5729	5734	5739	5744	5749	5754
5759	5764	5769	5774	5779	5784
5789	5794	5799	5804	5809	5814
5819	5824	5829	5834	5839	5844
5850	5856	5861	5866	5871	

Z5

Group 1 (2.4 GHz)					
Gr 1 - Ch 1		2405	2323	2441	2465
Gr 1 - Ch 2		2411	2429	2447	2471
Gr 1 - Ch 3		2417	2435	2453	2477
Group 2 (2.4 GHz)					
Gr 2 - Ch 1		2404	2424	2444	2464
Gr 2 - Ch 2		2409	2429	2449	2469
Gr 2 - Ch 3		2414	2434	2454	2474
Gr 2 - Ch 4		2419	2439	2459	2478
Group 3 (2.4 GHz)					
2405	2408	2411	2414	2417	2420
2423	2426	2429	2432	2435	2438
2441	2444	2447	2450	2453	2456
2459	2462	2465	2468	2471	2474
2477					
Group A (2.4 GHz)					
2405	2411	2417	2423	2429	2435
2441	2447	2453	2459	2465	2471
2477					
Group B (2.4 GHz)					
2404	2409	2414	2419	2424	2429
2434	2439	2444	2449	2454	2459
2464	2469	2474	2478		



Group 1 (5.8 GHz)					
Gr 1 - Ch 1		5730	5754	5778	5802
Gr 1 - Ch 2		5736	5760	5784	5808
Gr 1 - Ch 3		5742	5766	5790	5814
Gr 1 - Ch 4		5748	5772	5796	5820
Group 2 (5.8 GHz)					
Gr 2 - Ch 1		5729	5753	5778	5803
Gr 2 - Ch 2		5733	5758	5783	5808
Gr 2 - Ch 3		5738	5763	5788	5813
Gr 2 - Ch 4		5743	5768	5793	5817
Gr 2 - Ch 5		5748	5773	5798	5821
Group 3 (5.8 GHz)					
5730	5733	5736	5739	5742	5745
5748	5751	5754	5757	5760	5763
5766	5769	5772	5775	5778	5781
5784	5787	5790	5793	5796	5799
5802	5805	5808	5811	5814	5817
5820					
Group A (5.8 GHz)					
5730	5736	5742	5748	5754	5760
5766	5772	5778	5784	5790	5796
5802	5808	5814	5820		
Group B (5.8 GHz)					
5729	5734	5739	5744	5749	5754
5759	5764	5769	5774	5779	5784
5789	5794	5799	5804	5809	5814
5820					

IMPORTANT SAFETY INSTRUCTIONS

1. READ these instructions.
2. KEEP these instructions.
3. HEED all warnings.
4. FOLLOW all instructions.
5. DO NOT use this apparatus near water.
6. CLEAN ONLY with dry cloth.
7. DO NOT block any ventilation openings. Allow sufficient distances for adequate ventilation and install in accordance with the manufacturer's instructions.
8. DO NOT install near any heat sources such as open flames, radiators, heat registers, stoves, or other apparatus (including amplifiers) that produce heat. Do not place any open flame sources on the product.
9. DO NOT defeat the safety purpose of the polarized or grounding type plug. A polarized plug has two blades with one wider than the other. A grounding type plug has two blades and a third grounding prong. The wider blade or the third prong are provided for your safety. If the provided plug does not fit into your outlet, consult an electrician for replacement of the obsolete outlet.
10. PROTECT the power cord from being walked on or pinched, particularly at plugs, convenience receptacles, and the point where they exit from the apparatus.
11. ONLY USE attachments/accessories specified by the manufacturer.
12. USE only with a cart, stand, tripod, bracket, or table specified by the manufacturer, or sold with the apparatus. When a cart is used, use caution when moving the cart/apparatus combination to avoid injury from tip-over.



13. UNPLUG this apparatus during lightning storms or when unused for long periods of time.
14. REFER all servicing to qualified service personnel. Servicing is required when the apparatus has been damaged in any way, such as power supply cord or plug is damaged, liquid has been spilled or objects have fallen into the apparatus, the apparatus has been exposed to rain or moisture, does not operate normally, or has been dropped.
15. DO NOT expose the apparatus to dripping and splashing. DO NOT put objects filled with liquids, such as vases, on the apparatus.
16. The MAINS plug or an appliance coupler shall remain readily operable.
17. The airborne noise of the Apparatus does not exceed 70dB (A).
18. Apparatus with CLASS I construction shall be connected to a MAINS socket outlet with a protective earthing connection.
19. To reduce the risk of fire or electric shock, do not expose this apparatus to rain or moisture.
20. Do not attempt to modify this product. Doing so could result in personal injury and/or product failure.
21. Operate this product within its specified operating temperature range.

	This symbol indicates that dangerous voltage constituting a risk of electric shock is present within this unit.
	This symbol indicates that there are important operating and maintenance instructions in the literature accompanying this unit.



In the European Union and the United Kingdom, this label indicates that the batteries in this product should be collected separately and not be disposed of with household waste. Substances in batteries can have a potential negative impact on health

and environment and you have a role in recycling waste batteries thus contributing to the protection, preservation, and improvement of the quality of the environment. You should contact your local authority or retailer for details of the collection and recycling schemes available.

The equipment is intended to be used in professional audio applications.

EMC conformance testing is based on the use of supplied and recommended cable types. The use of other cable types may degrade EMC performance.

Changes or modifications not expressly approved by Shure Incorporated could void your authority to operate this equipment.

Please consider the environment, electric products and packaging are part of regional recycling schemes and do not belong to regular household waste.

WARNING

- Battery packs may explode or release toxic materials. Risk of fire or burns. Do not open, crush, modify, disassemble, heat above 140°F (60°C), or incinerate.
- Follow instructions from manufacturer
- Only use Shure charger to recharge Shure rechargeable batteries
- **WARNING:** Danger of explosion if battery incorrectly replaced. Replace only with same or equivalent type.
- Never put batteries in mouth. If swallowed, contact your physician or local poison control center
- Do not short circuit; may cause burns or catch fire
- Do not charge or use battery packs other than Shure rechargeable batteries
- Dispose of battery packs properly. Check with local vendor for proper disposal of used battery packs.
- Batteries (battery pack or batteries installed) shall not be exposed to excessive heat such as sunshine, fire or the like
- Do not immerse the battery in liquid such as water, beverages, or other fluids.
- Do not attach or insert battery with polarity reversed.
- Keep away from small children.
- Do not use abnormal batteries.
- Pack the battery securely for transport.

Note:

- This equipment is intended to be used in professional audio applications.
- EMC conformance is based on the use of supplied and recommended cable types. The use of other cable types may degrade EMC performance.
- Use this battery charger only with the Shure charging modules and battery packs for which it is designed. Use with other than the specified modules and battery packs may increase the risk of fire or explosion.
- Changes or modifications not expressly approved by Shure Incorporated could void your authority to operate this equipment.

Information to the user

This equipment has been tested and found to comply with the limits for a Class B digital device, pursuant to part 15 of the FCC Rules. This equipment generates, uses, and can radiate radio frequency energy and, if not installed and used in accordance with the manufacturer's instruction manual, may cause interference with radio and television reception.

Notice: The FCC regulations provide that changes or modifications not expressly approved by Shure Incorporated could void your authority to operate this equipment.

These limits are designed to provide reasonable protection against harmful interference in a residential installation. This equipment generates, uses, and can radiate radio frequency energy and, if not installed and used in accordance with the instructions, may cause harmful interference to radio communications. However, there is no guarantee that interference will not occur in a particular installation. If this equipment does cause harmful interference to radio or television reception, which can be de-

terminated by turning the equipment off and on, the user is encouraged to try to correct the interference by one or more of the following measures:

- Reorient or relocate the receiving antenna.
- Increase the separation between the equipment and the receiver.
- Connect the equipment to an outlet on a circuit different from that to which the receiver is connected.
- Consult the dealer or an experienced radio/TV technician for help.

This device complies with part 15 of the FCC Rules. Operation is subject to the following two conditions:

1. This device may not cause harmful interference.
2. This device must accept any interference received, including interference that may cause undesired operation.

Shure has determined that this product is a Class B harmonized product. The following sections provide country-specific EMC/EMI or product safety information.

Certifications

Certified under FCC Part 15.

FCC ID: DD4GLXD4RZ3, DD4GLXD1Z3, DD4GLXD2Z3 **IC:** 616A-GLXD4RZ3, 616A-GLXD1Z3, 616A-GLXD2Z3

CAN ICES-003 (B)/NMB-003(B)

The antenna(s) must be installed such that a minimum separation distance of 20 cm is maintained between the radiator (antenna) and all persons at all times.

La ou les antennes doivent être installées de telle façon qu'une distance de séparation minimum de 20 cm soit maintenue entre le radiateur (antenne) et toute personne à tout moment.

This equipment complies with FCC radiation exposure limits set forth for an uncontrolled environment. This equipment should be installed and operated with minimum distance 20 cm between the radiator & your body.

This product meets the applicable Innovation, Science and Economic Development Canada technical specifications. Certified by ISED in Canada under RSS-247 and RSS-GEN.

This device contains licence-exempt transmitter(s)/receiver(s) that comply with Innovation, Science and Economic Development Canada's licence-exempt RSS(s). Operation is subject to the following two conditions:

1. This device may not cause interference.
2. This device must accept any interference, including interference that may cause undesired operation of the device.

L'émetteur/récepteur exempt de licence contenu dans le présent appareil est conforme aux CNR d'Innovation, Sciences et Développement économique Canada applicables aux appareils radio exempts de licence. L'exploitation est autorisée aux deux conditions suivantes :

1. L'appareil ne doit pas produire de brouillage;
2. L'appareil doit accepter tout brouillage radioélectrique subi, même si le brouillage est susceptible d'en compromettre le fonctionnement.

This equipment complies with FCC and ISED radiation exposure limits set forth for an uncontrolled environment. End user must follow the specific operating instructions for satisfying RF exposure compliance. This transmitter must not be co-located or operating in conjunction with any other antenna or transmitter.

Cet équipement est conforme aux limites d'exposition aux rayonnements ISED établies pour un environnement non contrôlé. L'utilisateur final doit suivre les instructions spécifiques pour satisfaire les normes. Cet émetteur ne doit pas être co-implanté ou fonctionner en conjonction avec toute autre antenne ou transmetteur.

La operación de este equipo está sujeta a las siguientes dos condiciones: (1) es posible que este equipo o dispositivo no cause interferencia perjudicial y (2) este equipo o dispositivo debe aceptar cualquier interferencia, incluyendo la que pueda causar su operación no deseada.



Este equipamento não tem direito à proteção contra interferência prejudicial e não pode causar interferência em sistemas devidamente autorizados. Para maiores informações, consulte o site da ANATEL – <http://www.anatel.gov.br>.

해당 무선설비는 전파혼신 가능성이 있으므로 인명안전과 관련된 서비스는 할 수 없음

1. 取得審驗證明之低功率射頻器材，非經核准，公司、商號或使用者均不得擅自變更頻率、加大功率或變更原設計之特性及功能。低功率射頻器材之使用不得影響飛航安全及干擾合法通信；經發現有干擾現象時，應立即停用，並改善至無干擾時方得繼續使用。前述合法通信，指依電信管理法規定作業之無線電通信。低功率射頻器材須忍受合法通信或工業、科學及醫療用電波輻射性電機設備之干擾。
2. 應避免影響附近雷達系統之操作。
3. 高增益指向性天線只得應用於固定式點對點系統。

เครื่องโทรคมนาคมและอุปกรณ์นี้มีความสอดคล้องตามมาตรฐานหรือข้อกำหนดทางเทคนิคของ กสทช.

Paraguay Distributor: Microsystems S.R.L., Senador Long 664 c/Dr. Lilio, Asunción, Paraguay

Connection and use of this communications equipment is permitted by the Nigerian Communications Commission.

運用に際しての注意

この機器の使用周波数帯では、電子レンジ等の産業・科学・医療用機器のほか工場の製造ライン等で使用されている移動体識別用の構内無線局（免許を要する無線局）及び特定小電力無線局（免許を要しない無線局）並びにアマチュア無線局（免許を要する無線局）が運用されています。

1. この機器を使用する前に、近くで移動体識別用の構内無線局及び特定小電力無線局並びにアマチュア無線局が運用されていないことを確認して下さい。
2. 万一、この機器から移動体識別用の構内無線局に対して有害な電波干渉の事例が発生した場合には、速やかに使用周波数を変更するか又は電波の発射を停止した上、下記連絡先にご連絡頂き、混信回避のための処置等（例えば、パーティションの設置など）についてご相談して下さい。
3. その他、この機器から移動体識別用の特定小電力無線局あるいはアマチュア無線局に対して有害な電波干渉の事例が発生した場合など何かお困りのことが起きたときは、保証書に記載の販売代理店または購入店へお問い合わせください。代理店および販売店情報は Shure 日本語ウェブサイト <http://www.shure.co.jp> でもご覧いただけます。

現品表示記号について

2.4 XX 8

現品表示記号は、以下のことを表しています。この無線機器は 2.4GHz 帯の電波を使用し、変調方式は「その他」の方式、想定与干渉距離は 80m です。2,400MHz ~ 2,483.5MHz の全帯域を使用し、移動体識別装置の帯域を回避することはできません。

Waste Electrical and Electronic Equipment (WEEE) Directive



In the European Union and the United Kingdom, this label indicates that this product should not be disposed of with household waste. It should be deposited at an appropriate facility to enable recovery and recycling.

Registration, Evaluation, Authorization of Chemicals (REACH) Directive

REACH (Registration, Evaluation, Authorization of Chemicals) is the European Union (EU) and the United Kingdom (UK) chemical substances regulatory framework. Information on substances of very high concern contained in Shure products in a concentration above 0.1% weight over weight (w/w) is available upon request.

CE Notice:

Hereby, Shure Incorporated declares that this product with CE Marking has been determined to be in compliance with European Union requirements. The full text of the EU declaration of conformity is available at the following site: <https://www.shure.com/en-EU/support/declarations-of-conformity>.

Authorized European Importer / Representative:

Shure Europe GmbH
 Department: Global Compliance
 Jakob-Dieffenbacher-Str. 12
 75031 Eppingen, Germany
 Phone: +49-7262-92 49 0
 Fax: +49-7262-92 49 11 4
 Email: EMEAsupport@shure.de

UKCA Notice:

Hereby, Shure Incorporated declares that this product with UKCA Marking has been determined to be in compliance with UK-CA requirements. The full text of the UK declaration of conformity is available at the following site: <https://www.shure.com/en-GB/support/declarations-of-conformity>.

Authorized UK Importer / Representative:

Shure UK Limited
 Unit 2, The IO Centre, Lea Road,
 Waltham Abbey, Essex, EN9 1 AS, UK

- (一) 本产品符合“微功率短距离无线电发射设备目录和技术要求”的具体条款和使用场景；
- (二) 不得擅自改变使用场景或使用条件、扩大发射频率范围、加大发射功率（包括额外加装射频功率放大器），不得擅自更改发射天线；
- (三) 不得对其他合法的无线电台（站）产生有害干扰，也不得提出免受有害干扰保护；
- (四) 应当承受辐射射频能量的工业、科学及医疗（ISM）应用设备的干扰或其他合法的无线电台（站）干扰；
- (五) 如对其他合法的无线电台（站）产生有害干扰时，应立即停止使用，并采取措施消除干扰后方可继续使用；
- (六) 在航空器内和依据法律法规、国家有关规定、标准划设的射电天文台、气象雷达站、卫星地球站（含测控、测距、接收、导航站）等军民用无线电台（站）、机场等的电磁环境保护区域内使用微功率设备，应当遵守电磁环境保护及相关行业主管部门的规定。

部件名称	有害物质					
	铅	汞	镉	六价铬	多溴联苯	多溴二苯醚
电路模块	X	○	○	○	○	○
金属模块	X	○	○	○	○	○
线缆及其组件	X	○	○	○	○	○
外壳	○	○	○	○	○	○
电源适配器*	X	○	○	○	○	○
电池组*	X	○	○	○	○	○

本表格依据 SJ/T11364 的规定编制。

○: 表示该有害物质在该部件所有均质材料中的含量均在 GB/T26572 规定的限量要求以下。

X: 表示该有害物质至少在该部件某一均质材料中的含量超出 GB/T26572 规定的限量要求。

注: 本产品大部分的部件采用无害的环保材料制造, 含有有害物质的部件皆因全球技术发展水平的限制而无法实现有害物质的替代。

*:表示如果包含部分