



OWNER'S MANUAL

LG Digital Signage

(MONITOR SIGNAGE)

Please read the user manual before using this product to ensure safe and convenient use.

22XE1J

TABLE OF CONTENTS

BASIC 3

- Checking the Accessories..... 3
- Checking the Product Components..... 4

GETTING READY 4

- Connecting the Cables..... 4

CHECKING BEFORE

INSTALLATION 10

- Installation Orientation..... 10
- Installation Location..... 12
- Wall Mount Holder..... 14
- Safety and Precaution Guide
for Installation 15

INSTALLING THE

PRODUCT..... 21

- Installation Conditions..... 21
- Precautions When Designing a Case 22

PRECAUTIONS FOR USE..... 30

- Dust..... 30
- Afterimage..... 30

PRODUCT

SPECIFICATIONS..... 32

LICENCE..... 35

WARNING - This equipment is compliant with Class A of CISPR 32. In a residential environment this equipment may cause radio interference.

BASIC

! NOTE

- The accessories provided with your product may vary depending on the model or region.
- Product specifications or contents in this manual may be changed without prior notice due to upgrade of product functions.
- SuperSign Software & Manual
 - Visit <http://partner.lge.com> to download the latest SuperSign software and manual.

Checking the Accessories

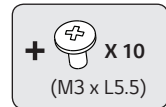
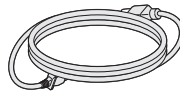
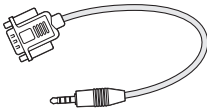
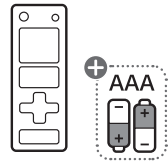
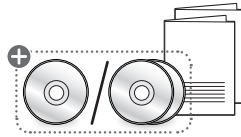

+ Depending on country

Checking the Product Components

The illustrations may differ depending on the model.

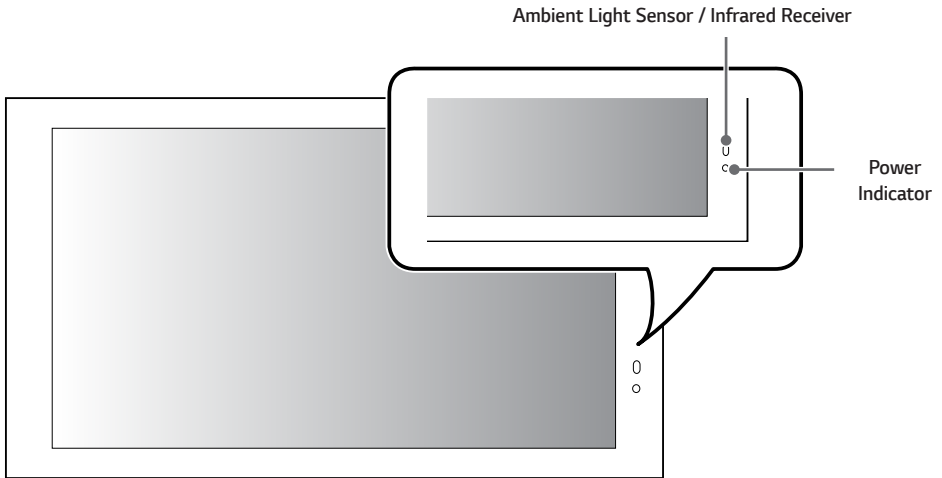

- **Ambient Light Sensor:** Adjusts the screen brightness by measuring the amount of light.
- **Infrared Receiver:** The part that receives the signal from the remote control.
- **Power Indicator:** Lights up red when the screen is turned on normally. The light turns orange when in sleep mode.

GETTING READY

Connecting the Cables

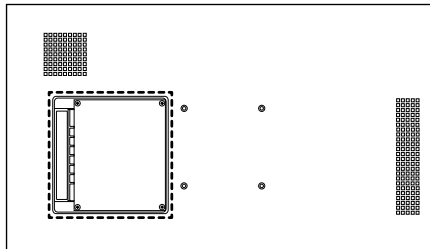

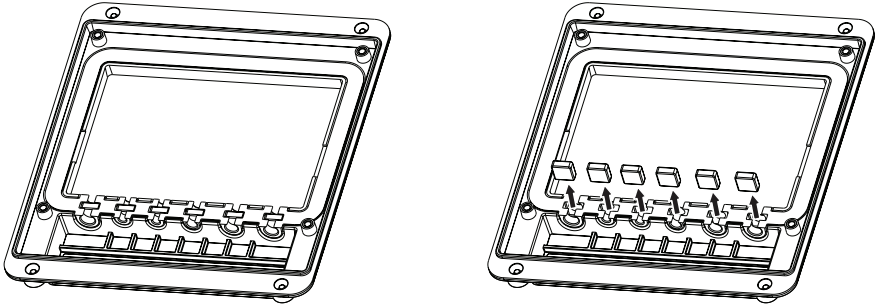

Power Cord Insertion
(Angle)

Power Cord Insertion
(Straight)

Remove the square rubbers before connecting the cables.

- Φ 7: insert power cord (Angle)
- Φ 6.5: insert power cord (Straight)

⚠ CAUTION

- Do not remove the square rubbers when the cables are not connected.
- If the square rubbers are not inserted without a cable, water may enter the product and cause malfunction, which is not covered by the warranty.

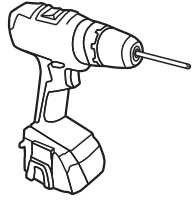

1

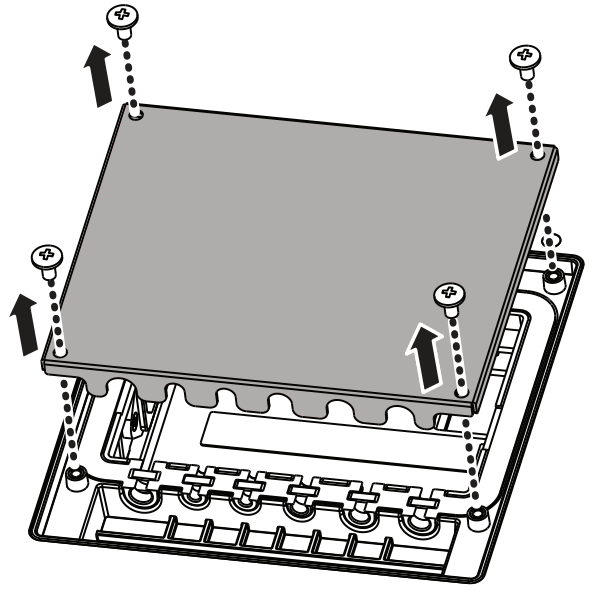

Power Cord Insertion (Angle)

Power Cord Insertion (Straight)

2-A

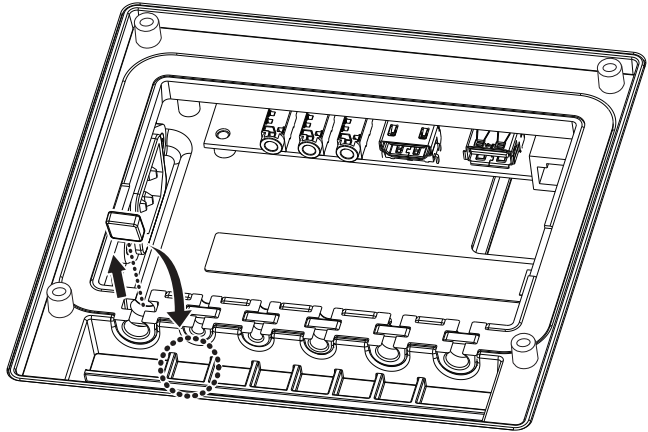
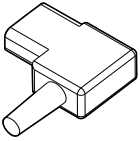

Power Cord Insertion
(Angle)

2-B

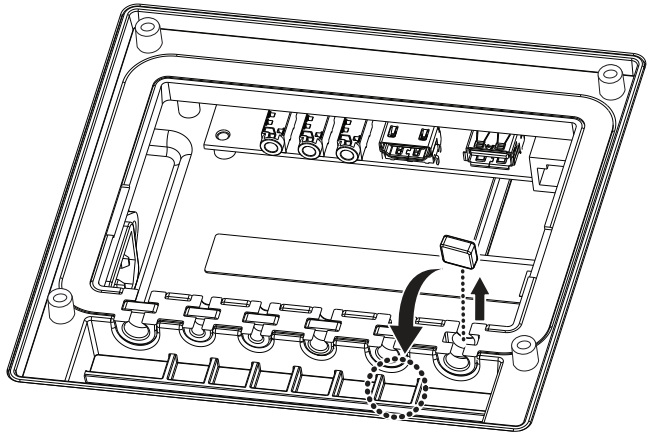
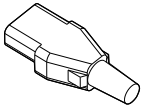

Power Cord Insertion
(Straight)

3-A

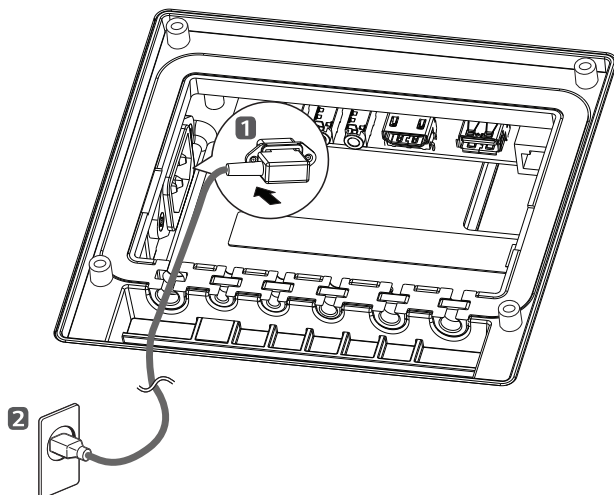
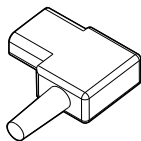

3-B

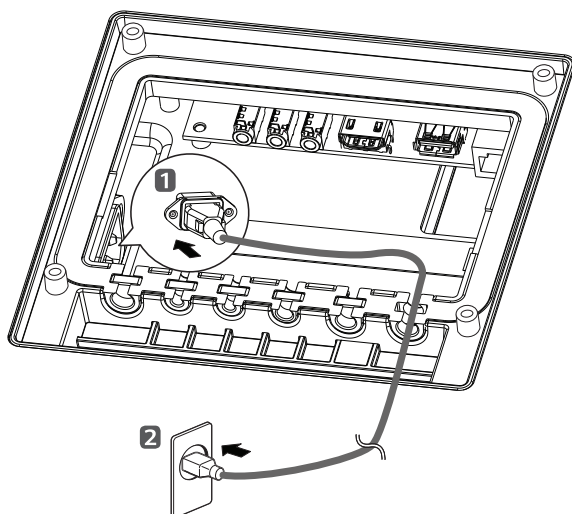
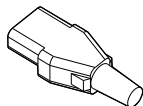

4-A

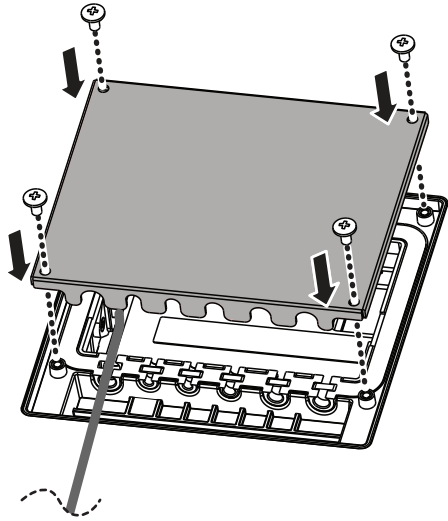
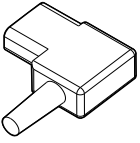

4-B

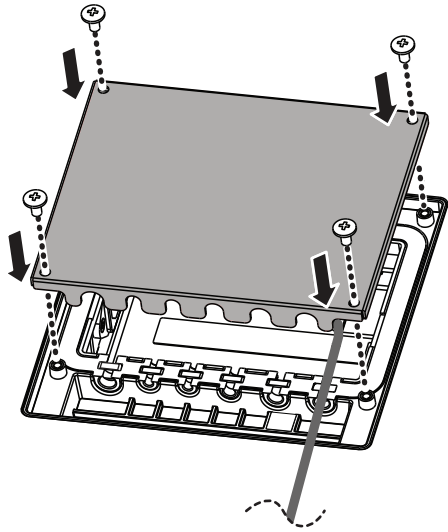
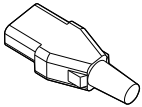

CHECKING BEFORE INSTALLATION

We are not responsible for product damage caused by failure to follow the guide.

Installation Orientation

Using Vertically

When installing vertically, rotate the monitor 90 degrees clockwise while facing the front of the screen.

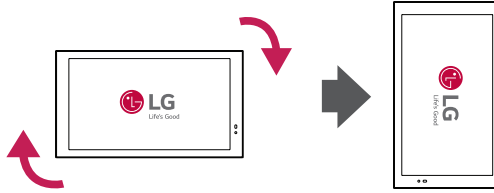

Tilt Angle

You can install the product by tilting it horizontally or vertically.

You can tilt the product up to 15 degrees for installation, while the product should be spaced at least 40 mm apart from the wall.

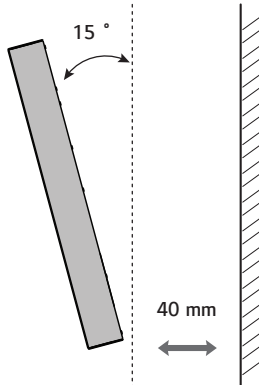

Ceiling, Floor Orientation

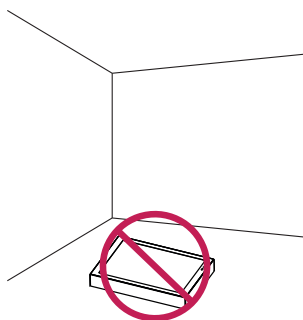
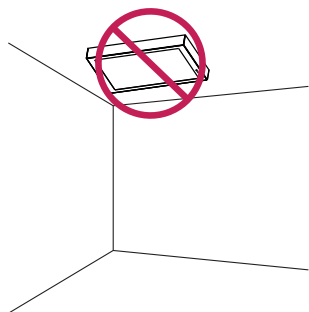

CAUTION

- Do not hang the product on the ceiling or lay it on the floor.

Installation Location

We are not responsible for product damage caused by failure to follow the guide.

Outdoor

Installing on a Wall

- When installing the product on a wall, install a partition to separate the air from the inlet and outlet. Otherwise, the product may malfunction, which is not covered by the warranty.
- Install a partition between the wall and the product to prevent the inlet and outlet air from mixing.

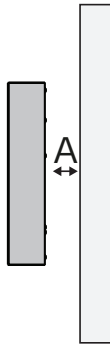

A: 40 mm or more

Installing on a Recessed Wall

Do not install the product on a recessed wall. When installing on a recessed wall, heat may cause damage to the panel and parts, in which case it is not covered by the warranty.

Installation of the Cased Product

- When installing a separate case outside the product and installing it near a wall, a minimum distance of 100 mm or more is required.
- Do not block the ventilation openings or place objects near them.

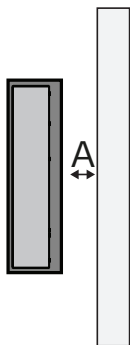

A: 100 mm or more

Installation Area

- Do not allow foreign substances such as snow to accumulate on the inlet and outlet of the product.
- The warranty will not cover any damage caused by using the product in an excessively dusty environment.

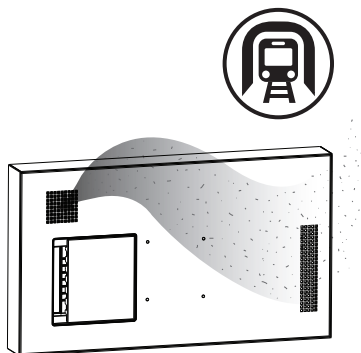
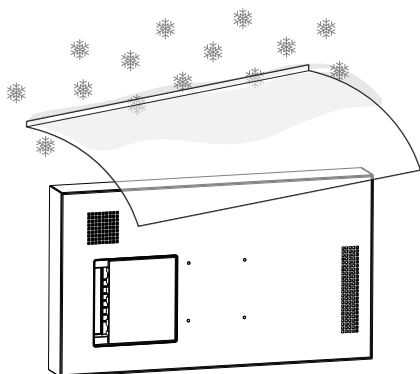

Wall Mount Holder

To install the monitor on a wall, attach a wall mount holder (optional) to the back of the monitor. Take caution, and ensure that the wall mount holder (optional) is securely fixed to the monitor and to the wall. The VESA dimensions of the wall mount by model are as follows.

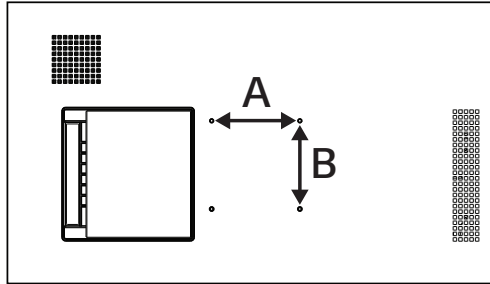

Model	VESA Dimensions (A x B) (mm)	Standard Dimensions	Length (Maximum) (mm)	Quantity
22XE1J	100 x 100	M4	8.5	4

CAUTION

- Disconnect the power cord first, and then move or install the monitor. Otherwise, it may result in electric shock.
- If the monitor is installed on a ceiling or inclined wall, it may fall and result in injury.
- Damage to the monitor by tightening the screws too tightly may void your warranty.
- Use screws and wall mount plates conforming to VESA standards. Breakage or personal injury due to use or misuse of inappropriate components is not covered by the warranty of this product.

NOTE

- Using screws longer than the indicated depth may damage the inside of the product. Be sure to use the proper length.
- For more information on installation, please refer to the user manual for the wall mount.

Safety and Precaution Guide for Installation

When Exposed to Direct Sunlight

- While powered off, make sure the device is not exposed to direct sunlight for a prolonged period.
 - Protect the display with cloth or a box when storing the device after it has been powered off.
 - This can prevent faults such as black spots, creases, and yellowing.
- After connecting the power, activate the [Screen Off & Backlight On (Outdoor)] feature.
 - Turning the screen off can help prevent black spots, creases, yellowing, condensation, and malfunctions due to moisture.
 - For the [Screen Off & Backlight On (Outdoor)] feature, please refer to the User Guide on our homepage.
 - At sub-zero temperatures, the display will be able to turn on after the internal temperature rises.

CAUTION

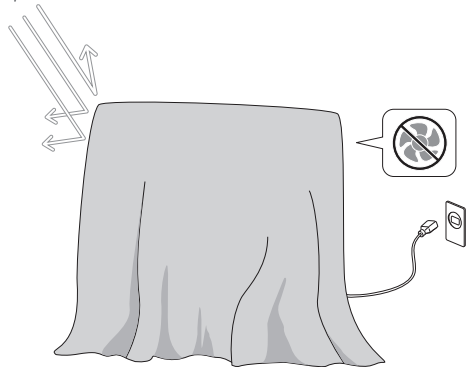
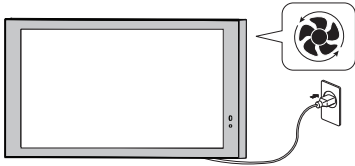

Preventing Condensation**⚠ CAUTION****• Screw Fastening**

- Fasten all of the screws on the back cover and interface cover of the product.
- If you fail to fasten any of the screws, moisture may enter the product and condensation may occur.

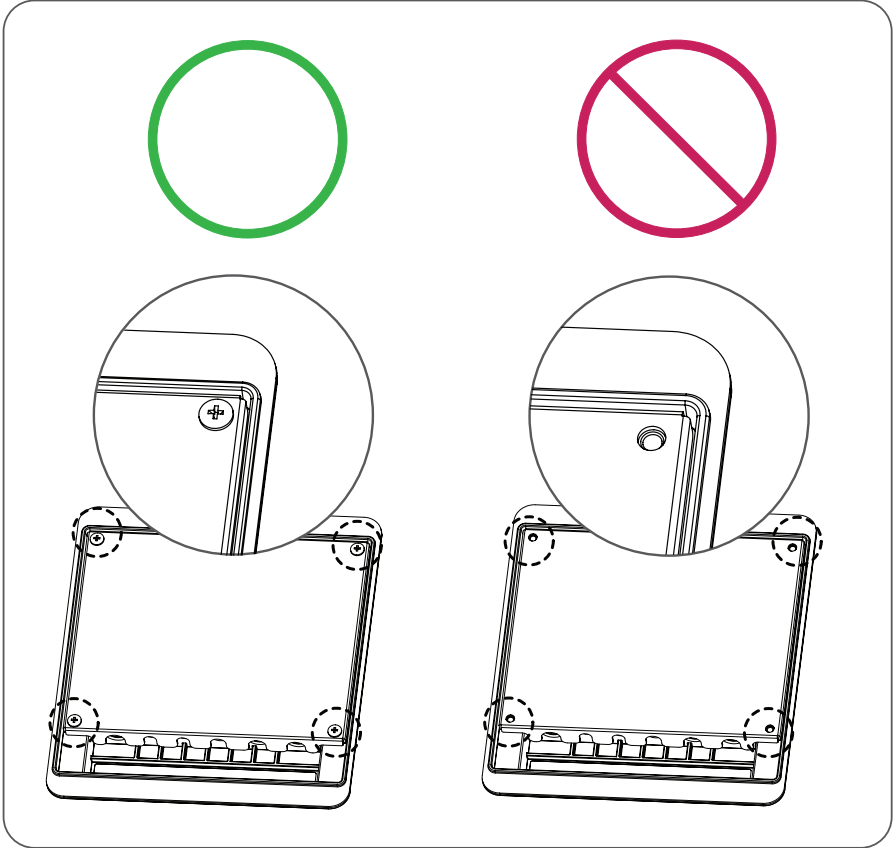

⚠ CAUTION

- Cable Ring
 - Insert all of the square rubber gaskets into the cable insert.
 - When using a cable, remove the square rubber gaskets and insert the cable that matches the dimensions of the cable insert so that there is no gap.

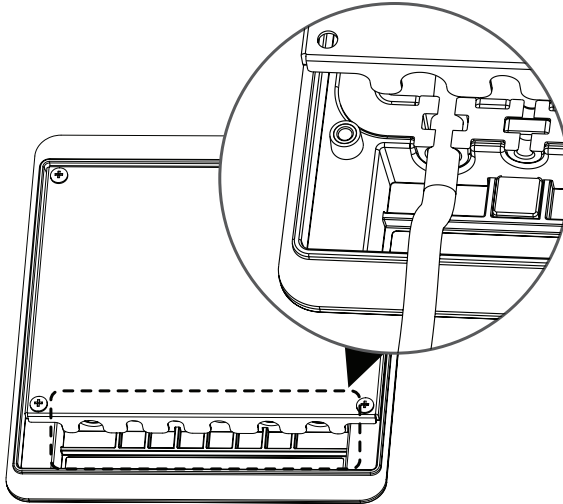

Power Cord Insertion
(Angle)

Power Cord Insertion
(Straight)

- 7 Ø hole: For 7 - 7.5 Ø cable insertion.
- 6 Ø hole: For 6 - 6.5 Ø cable insertion.
- 5 Ø hole: For 5 - 5.5 Ø cable insertion.
- 3.5 Ø hole: For 3.5 - 4 Ø cable insertion.

- Remove the square rubber gaskets only where the cable is inserted.

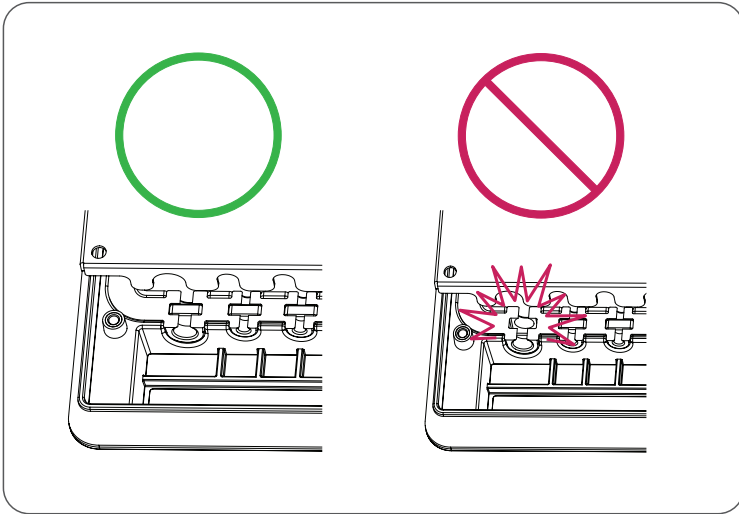

- Insert the cable by pressing it in fully to ensure there is no gap.

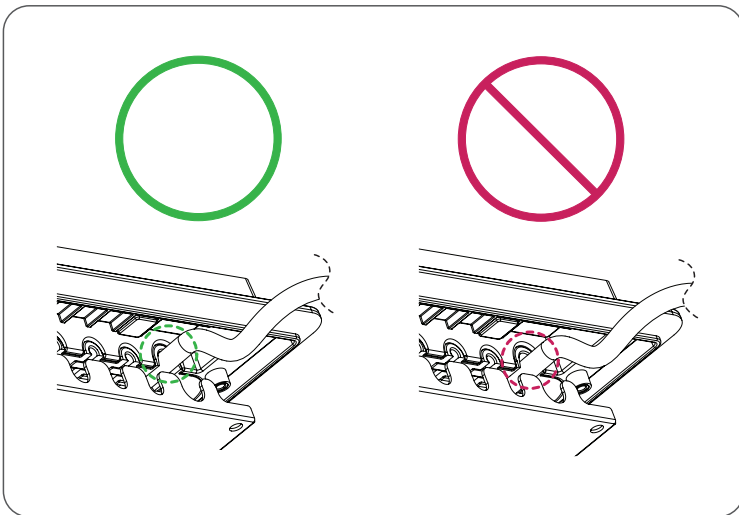

- Use a cable that fits the size of the hole in the cable insert.
- If the cable used is too thick and creates a gap, moisture may enter.

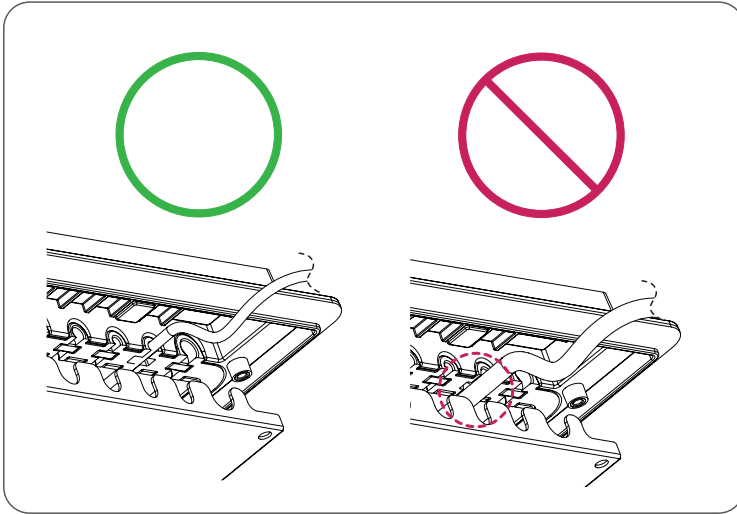

- If the cable used is too thin and creates a gap, moisture may enter.

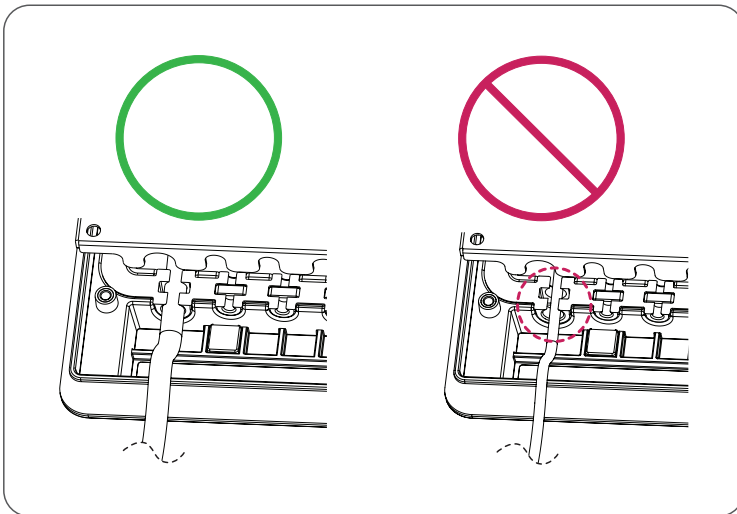

⚠ CAUTION

- [Fan Status]
- Check whether the fan is operating normally in the [Fan Status] menu with the remote control.
- ⚙ (Settings) → [General] → [System Information] → [Fan Status]

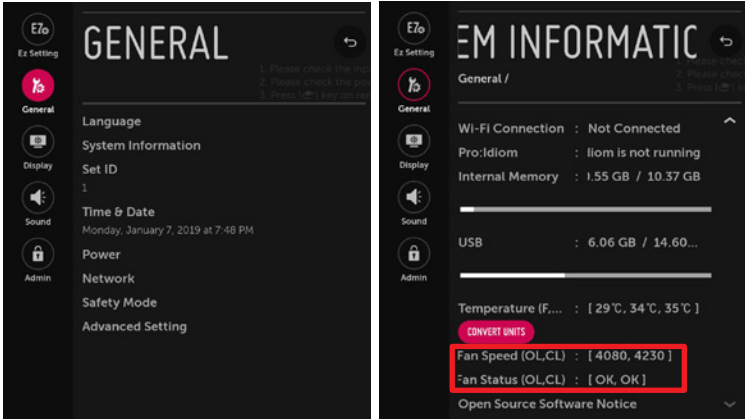

⚠ CAUTION

- [PM Mode]
- Outdoor preference must be turned on to prevent condensation.
- ⚙ (Settings) → [General] → [Power] → [PM Mode] → [Screen Off & Backlight On]

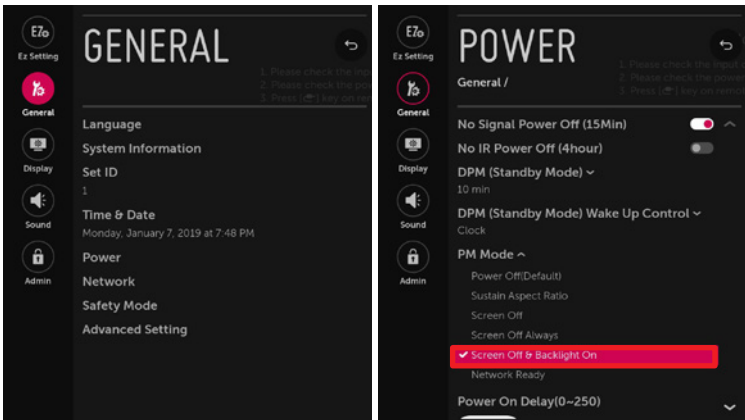

⚠ CAUTION

- Observe all precautions to prevent condensation. Otherwise, the product may have problems with condensation and waterproof performance, which will void the warranty.

INSTALLING THE PRODUCT

Installation Conditions

Inlet and Outlet Direction

- For cooling, the inlet uses a fan to draw in air and exhaust hot air to the outlet.

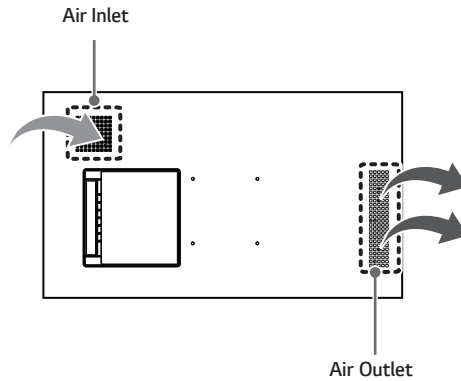

Definitions of Inlet and Outlet Terminology

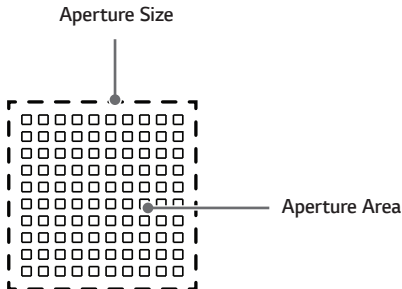

- **Aperture Size:** The size of the rectangular area of the inlet and outlet
- **Aperture Area:** The sum of the aperture area excluding the grate from the aperture size
- **Aperture Ratio:** $\text{Aperture Area} / \text{Aperture Size} \times 100 (\%)$

! NOTE

- Do not block the air vent of the product or place any obstacles nearby.

Precautions When Designing a Case

- Separate the inlet and outlet with a partition.
- Place an item such as a sponge pad between the partition and the product to completely block airflow.
- Place the air vent of the case close to the air vent of the product so that the air circulates well in the product.

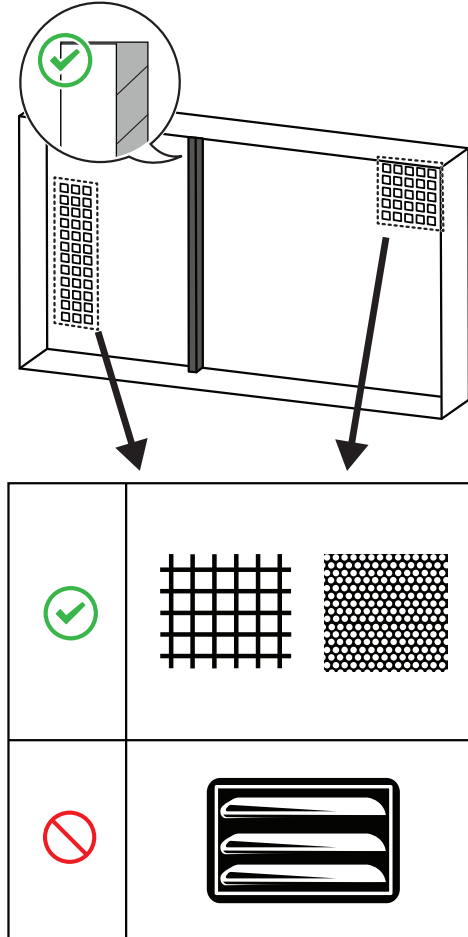

Precautions on Partition Designing When Installing the Media Player

- When installing a media player as an external component, ensure it is separated from the product.

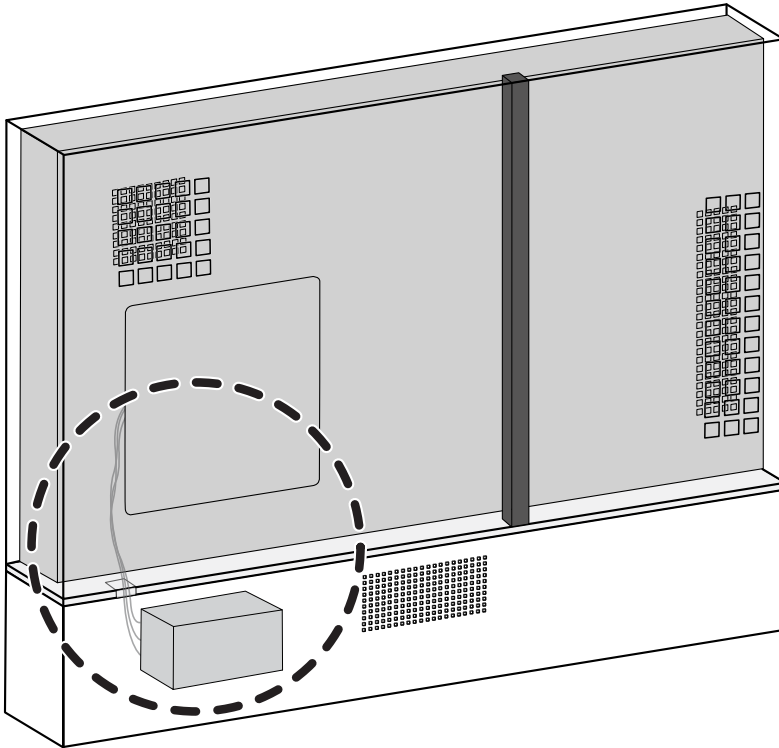

! NOTE

- When applying a partition between the media player and the product, there should be no gaps other than cables.
- A media player, which is sold separately, may result in product defects by increasing the temperature inside the product due to additional heat.
 - Such defects are not covered by the warranty.
- If the partition is not applied, air from the air vent may re-enter the product through the inlet.
 - In this case, the heat dissipation performance of the product may be reduced, which is not covered by the warranty.

Inlet and Outlet Design

- In all cases, the aperture ratio of the case must be at least 50 %.

For Stand-Alone Installation

- Make sure to separate the inlet and outlet to prevent the air around one from entering the other.

When Drilling the Inlet and Outlet on the Back of the Case

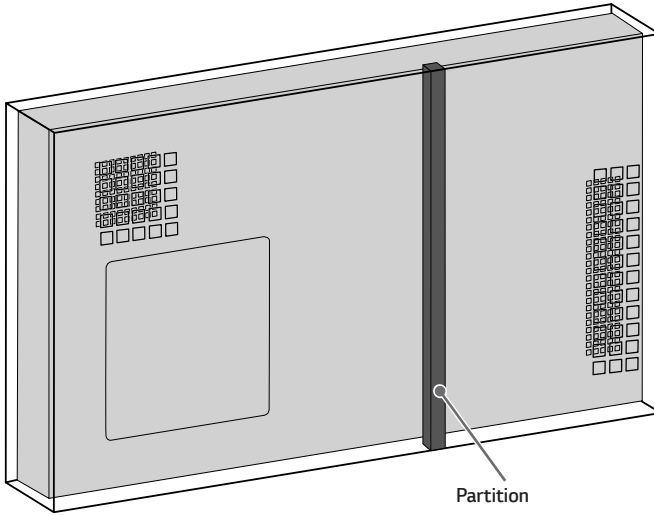

- Aperture Size

Air Inlet	35,000 mm ² or more
Air Outlet	105,000 mm ² or more

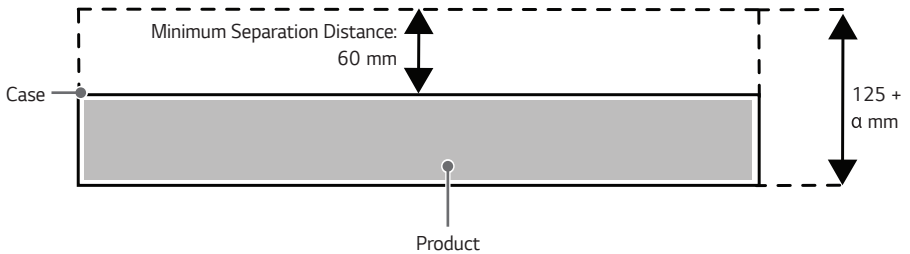

When Drilling the Inlet and Outlet on the Side of the Case

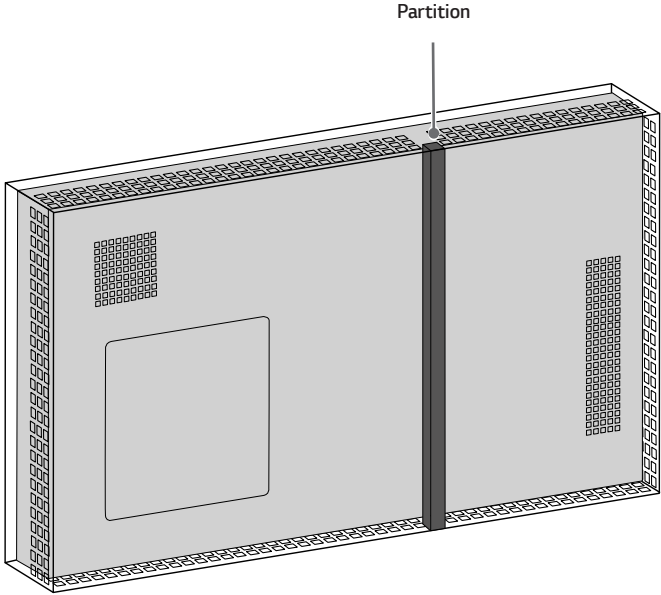

• Aperture Size

Air Inlet	144,000 mm ² or more
Air Outlet	210,000 mm ² or more

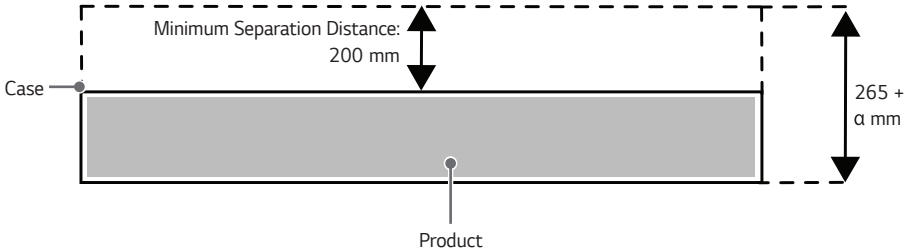

For 1 x N Line Installation

- When installing more than one product together, make sure to separate the inlet and outlet to prevent the air around one from entering another.
- When installing multiple products together, drill the case air vent on the backside, not the side.

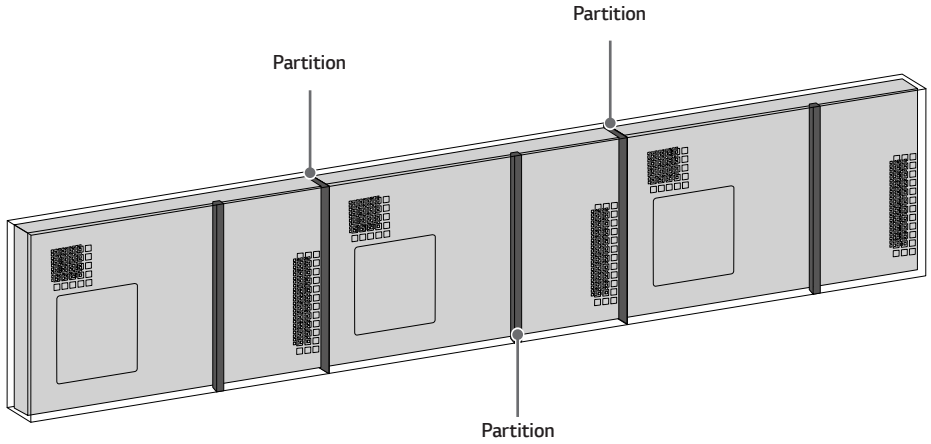

• Aperture Size

Air Inlet	35,000 x N mm ² or more
Air Outlet	105,000 x N mm ² or more

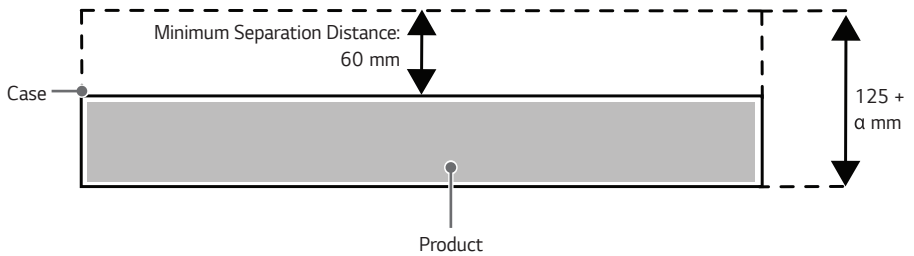

When Designing Both Sides

- When installing products in a back-to-back configuration, make sure to separate the inlet and the outlet to prevent the air around one from entering another.
- When installing the product on both sides, place the air vent on the top, bottom, left, and right sides.
- The thickness of the material installed between the two products is not included in the separation distance. (Separation distance between products: 200 mm)

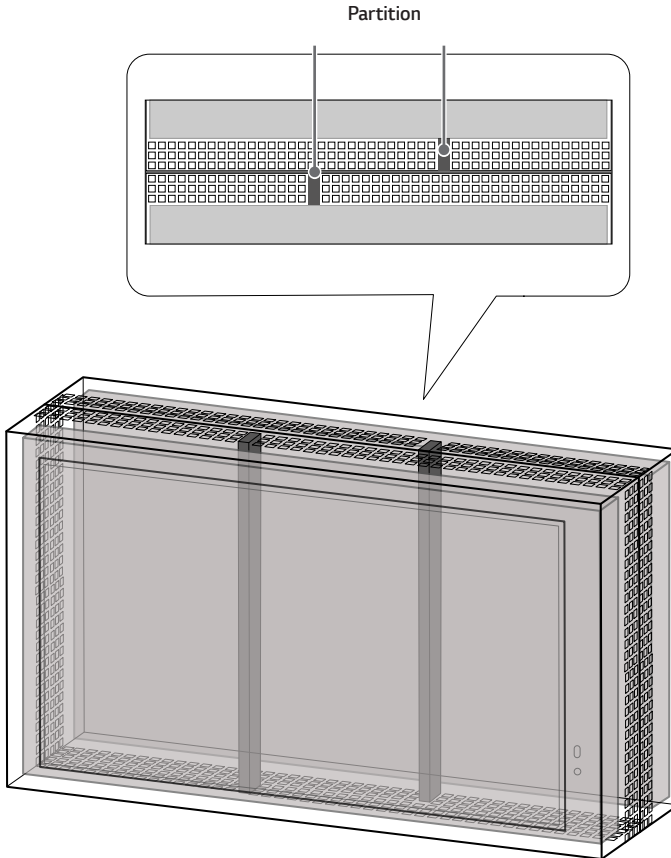

- Aperture Size

Air Inlet	175,600 mm ² or more
Air Outlet	175,600 mm ² or more

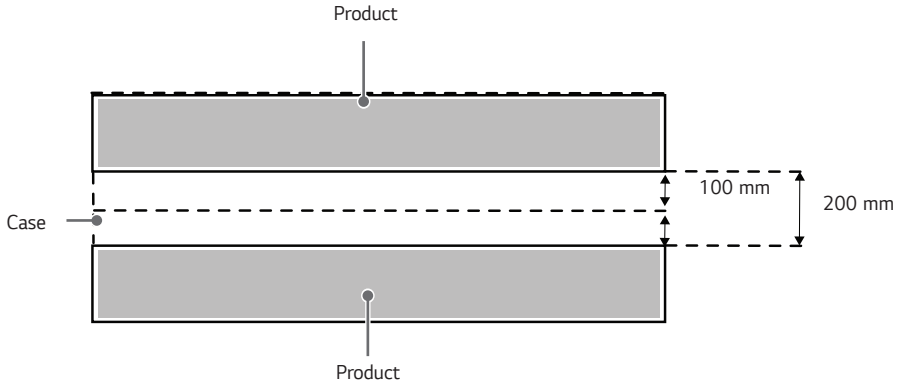

CAUTION

- When designing the inlet and outlet, the above aperture area must be satisfied. Failure to do so may result in issues with the product, which are not covered by the warranty.
- When installing a separate case on the product, consider the recommended aperture area and aperture ratio when designing. Failure to meet the recommended aperture plane and aperture ratio may cause the product to malfunction. In such cases, the warranty does not apply.

NOTE

- The partition should be in close contact with both the case and the product when installed.
- It is recommended that the inlet and outlet be positioned at the same location as the product.
- If possible, install an air vent around the inlet and outlet of the product.
- When installing on both sides or installing multiple products together, the aperture area must be increased by the number of products installed.
- The images in the User Manual are for horizontal installation. However, vertical installation is also possible, in which case it is necessary to secure the same aperture area.

When Connecting a Media Player/PC Inside

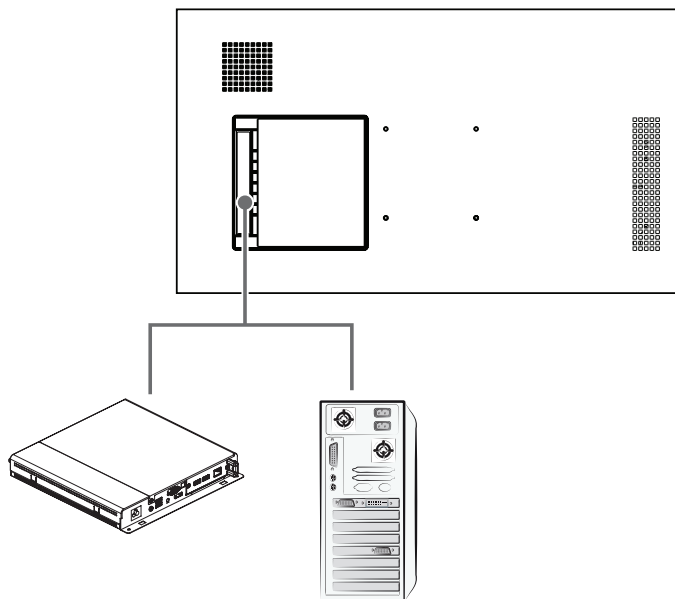

! NOTE

- When configuring the tile mode with HDMI, you cannot view the contents with HDCP applied.
- If the signal cable between the PC and the product is long, use a booster or an optical cable.
- HDMI IN, USB 2.0 IN, LAN can only be connected when connecting a media player/PC externally.

PRECAUTIONS FOR USE

WARNING

- Do not put metals such as coins, hairpins, or metal attachments, or flammable objects such as paper or matches into the product.

Dust

The warranty will not cover any damage caused by using the product in an excessively dusty environment.

Afterimage

- After-image appears when the product is turned off.
 - Pixels may be damaged rapidly if a still image is displayed on the screen for a long period of time. Use the screen-saver function.
 - Switching from a screen with high differences in luminance (black and white or grey) to a darker screen may cause an afterimage. This is normal due to the display characteristics of this product.
- When the LCD screen is in a still pattern for extended periods of use, a slight voltage difference may occur between the electrodes that operate the liquid crystal (LC). The voltage difference between the electrodes increases over time and tends to keep the liquid crystal aligned in one direction. At this time, the previous image remains, which is called an afterimage.
- Afterimages do not occur when continuously changing images are used but take place when a certain screen is fixed for a long time. The following are operational recommendations for reducing the occurrence of afterimages when using a fixed screen. The maximum recommended time for switching the screen is 12 hours. Shorter cycles are better for preventing afterimages.

- Recommended Usage Condition

- 1 Change the background colour and text colour at equal intervals.

- Afterimages occur less when the colours to be changed are complementary to one another.

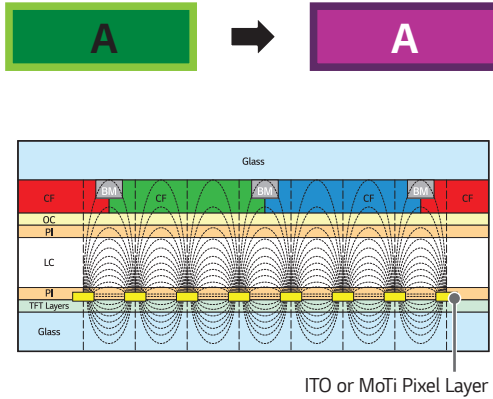

- 2 Switch the screen at equal time intervals.

- Take caution, and ensure that text or images from before the screen change are not left in the same location after the screen change.



PRODUCT SPECIFICATIONS

Without prior notice, all product information and specifications contained in this manual are subject to change to improve the performance of the product.

Input/Output Ports	HDMI IN, USB 2.0 IN, LAN IN, SPEAKER OUT, RS-232C IN	
Embedded battery	Applied	
Resolution	Recommended Resolution	1920 × 1080 @ 60 Hz
	Max Resolution	- This may not be supported on some OS or graphics card types.
Power Voltage	100-240 V - 50/60 Hz 1.2 A	
Environmental Conditions	Operating Temperature	-30 °C to 50 °C
	Operating Humidity	5 % to 100 % (Condition for preventing condensation)
	Storage Temperature	-20 °C to 60 °C
	Storage Humidity	5 % to 100 % (Condition for preventing condensation) * Product box packaging storage conditions
Power Consumption	On Mode	85 W (Typ.) / 115 W (Max.)
	Sleep Mode / Standby Mode	≤ 0.5 W

Model Name	Dimensions (Width x Height x Depth) (mm)	Weight (kg)
22XE1J-BJ	557.3 x 319.8 x 65.0	8.3
22XE1J-BM	557.3 x 319.8 x 66.0	8.7

HDMI (PC) Support Mode

Resolution	Horizontal Frequency (kHz)	Vertical Frequency (Hz)
640 x 480	31.469	59.94
800 x 600	37.879	60.317
1024 x 768	48.363	60
1280 x 720	44.772	59.855
1366 x 768	47.712	60
1280 x 1024	63.981	60.02
1680 x 1050	65.29	59.954
1920 x 1080	67.5	60

HDMI (DTV) Support Mode

Resolution	Horizontal Frequency (kHz)	Vertical Frequency (Hz)
480/60p	31.5	60
576/50p	31.25	50
720/50p	37.5	50
720/60p	45	60
1080/50i	28.1	50
1080/60i	33.75	60
1080/50p	56.25	50
1080/60p	67.5	60

Wireless module(LGSBWAC72) Specifications	
Wireless LAN (IEEE 802.11a/b/g/n/ac)	
Frequency range (MHz)	Output power (Max.) (dBm)
2400 to 2483.5	14
5150 to 5725	16.5
5725 to 5850 (Not for EU)	11.5
Bluetooth	
Frequency range (MHz)	Output power (Max.) (dBm)
2400 to 2483.5	8.5
<ul style="list-style-type: none"> As band channels can vary per country, the user cannot change or adjust the operating frequency. This product is configured for the regional frequency table. For consideration of the user, this device should be installed and operated with a minimum distance of 20 cm between the device and the body. "IEEE 802.11ac" is not available in all countries. 	

(Only Nigeria)

Connection and use of this communications equipment is permitted by the Nigerian Communications Commission

(Only HongKong)

Wireless module(LGSBWAC72) Specifications	
Wireless LAN (IEEE 802.11a/b/g/n/ac)	
Frequency range (MHz)	Output power (Max.) (dBm)
2400 to 2483.5	14
5150 to 5350	16.5
5725 to 5850	11.5
Bluetooth	
Frequency range (MHz)	Output power (Max.) (dBm)
2400 to 2483.5	8.5
<ul style="list-style-type: none"> As band channels can vary per country, the user cannot change or adjust the operating frequency. This product is configured for the regional frequency table. For consideration of the user, this device should be installed and operated with a minimum distance of 20 cm between the device and the body. 	

LICENCE

Supported licenses may differ by model. Visit www.lg.com for more information on licenses.



The terms HDMI, HDMI High-Definition Multimedia Interface, HDMI trade dress and the HDMI Logos are trademarks or registered trademarks of HDMI Licensing Administrator, Inc.

Manufactured under license from Dolby Laboratories. Dolby, Dolby Vision, Dolby Vision IQ, Dolby Audio, Dolby Atmos, and the double-D symbol are trademarks of Dolby Laboratories Licensing Corporation.

For DTS patents, see <http://patents.dts.com>. Manufactured under license from DTS Licensing Limited. DTS, the Symbol, & DTS and the Symbol together, DTS 2.0 Channel, DTS 2.0+Digital Out, DTS-HD, and DTS Virtual:X are registered trademarks or trademarks of DTS, Inc. in the United States and/or other countries. © DTS, Inc. All Rights Reserved.



The Bluetooth® word mark and logos are registered trademarks owned by Bluetooth SIG, Inc. and any use of such marks by LG Electronics Inc. is under license. Other trademarks and trade names are those of their respective owners.



The model and serial number of the product are located on the back and on one side of the product. Record them below in case you ever need service.

MODEL _____

SERIAL NO. _____

Temporary noise is normal when powering ON or OFF this device.